



THIELE®



**DISTRIBUIDOR
AUTORIZADO**

MEX (55) 53 63 23 31 MTY (81) 83 54 10 18
QRO (442) 1 95 72 60 ventas@industrialmagza.com



THIELE Lifting Products

Grade 100 (XL-Program)



Product Overview **THIELE** Lifting Products Grade 100

TWN 1805	TWN 0072
Page 28 – 29	Round Steel Link Chains

TWN 1813	TWN 1814	TWN 1815	TWN 1795	TWN 1810/1
TWN 1810/2	TWN 1810/4	TWN 1819		
Page 30 – 34	Suspension Components			

TWN 1820	
Page 34	Connector XL-LOK®

TWN 1836	TWN 1837	TWN 1840/1	TWN 1841/1	TWN 1856
Page 35 – 37	Hooks			



<p>TWN 1827</p> 	<p>TWN 1827/1</p> 	<p>TWN 1851</p> 	<p>TWN 1852</p> 	
<p>TWN 1896</p> 				
<p>Page 37 – 40 Shortening Components</p>				



<p>TWN 1871</p> 	
<p>Page 40 Shackles</p>	

<p>TWN 1454</p> 	<p>TWN 1455</p> 	
<p>Page 41 – 42 Chain Tensioners</p>		



TWN 1869



TWN 1812



Page 43 – 44

Special Sling Components

TWN 1410



TWN 1411



Page 44 – 45

Lashing Chains

TWN 0944



TWN 0945



TWN 1402



TWN 1904/0

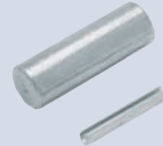

TWN 1908/0



TWN 1921



TWN 1930/0



TWN 1931/0



TWN 1933/0



TWN 1935

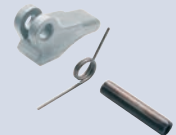

TWN 1950



TWN 1951

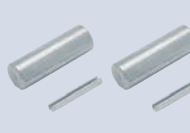

TWN 1940



TWN 1946



TWN 0968

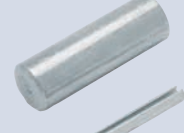

TWN 0969



Page 45 – 50

Spare Parts and Accessories



TWN 1601/1-Leg



TWN 1651/2-Leg



TWN 1751/4-Leg



Page
51 – 55

Chain Slings



Page
56

Shortening Options

Form K11



Form K12



Form K22



Page
57

Endless Chains



Comparison between Grade 80 and Grade 100

Grade 100 – up to 30% weight reduction on a 2-Leg Chain Sling compared to equivalent Grade 80 Sling.

Article	THIELE Plant Standard	Pieces
Master Link	TWN 1813	1
XL-LOK®	TWN 1820	2
2 m Round Steel Link Chain	TWN 1805	2
Clevis Sling Hook	TWN 1840/1	2

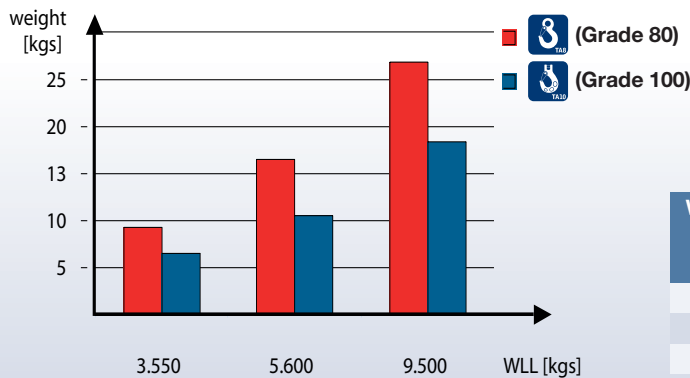

Working Load Limit [t max.]	TA8 Weight [kgs]	TA10 Weight [kgs]	Weight-reductions [%]
3,55	9,3	6,5	30
5,60	16,5	10,6	35
9,00	26,8	18,4	31

Properties	Grade	TA8	TA10 – XL400
Working Load Limit (WLL)			25 % stronger
Safety Factor	4		4 (-7 %)
Elongation at break (completed finish)	min. 20 %		min. 20 %
Weight			app. 30 % less
Nominal Size			same as Grade 80
Breaking Stress	min. 800 N/mm ²		min. 1000 N/mm ²
Component Strength	1150-1250 MPa		1450-1550 MPa
Load Factor	acc. to catalogue		same as GK8
Temperature Application Range	-40 – 200 °C (100 %) ¹⁾ 200 – 300 °C (90 %) ¹⁾ 300 – 400 °C (75 %) ¹⁾		-30 – 200 °C (100 %) ¹⁾ 200 – 300 °C (90 %) ¹⁾ 300 – 380 °C (60 %) ¹⁾
Asymmetry Factor	acc. to catalogue		same as Grade 80
Acids and Lyes	not allowed		not allowed
Compatibility with other system	possible		restricted
Colour Round Steel Link Chains (AQUA lacquer)	black painted (RAL 9005)		ultramarine blue painted (RAL 5002)
Colour Forgings	powder painted red (RAL 3003)		ultramarine blue powder painted (RAL 5002)
Standards	European and International		PAS 1061 (Manufactures Recommendation)
Life cycle			less wear

¹⁾ Related to nominal Working Load Limit.



Selection Criteria for Chain Slings

1. Determine the **weight of the load** to be lifted.
2. Check **number of chain-legs** required (depending on the numbers of existing lifting points).
3. Determine the **trade size** by taking the **inclination angle** into consideration
(see table 1 on page 25 and table 2 and 3 on page 26).
4. Consider possible (extreme) **temperature influences** (see special advices page 27).
5. Consider that **asymmetry** may influence the load factor (see table 4 on page 27).
6. Choose the **master links, shortening elements** and **components** suitable for the selected chain trade size.
7. Determine the **chain length** by considering the total effective reach.
8. Control (inspect) selected components and/or in-use chain slings to ensure that they meet or exceed all applicable industry and government safety-laws and regulations (acc. to DGUV).



Special Advices:

Please also consider more complicated conditions of use, such as intermittent impacts or loads when selecting the Grade 100 slings and/or components. The maximum application temperature for Grade 100 products must be taken into consideration. If the slings were used above the maximum temperature, then they have to be immediately rejected. Please contact the manufacturer. The THIELE-assembly system must not be used in the case of chemical influences such as acids and/or lyes.

THIELE Plant Standard (TWN)

THIELE plant standard fulfills the requirements of the EG-directive for machines, particularly for the safety relevant components. The working load limit and the test requirements meet or exceed the European standards.



Chain Inspection Gauge



Inspection of material diameter



Inspection of permanent elongation



Pitch inspection

Material diameter

Pitch inspection

Front side

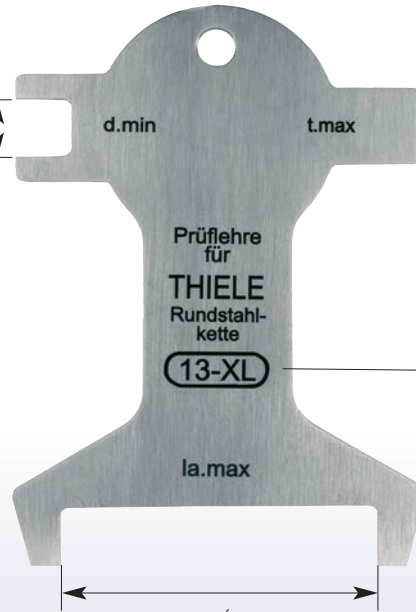

Trade size

Inspection of permanent elongation

Back side



Identification Tag

The use of a chain sling without identification tag is permitted.

The data on the identification tag are in accordance to the EN 818-4 for chain slings. The THIELE Grade 100 identification tag differs particularly by shape (decagon) and colour (RAL 5002) from other Grades.

Front side



Back side

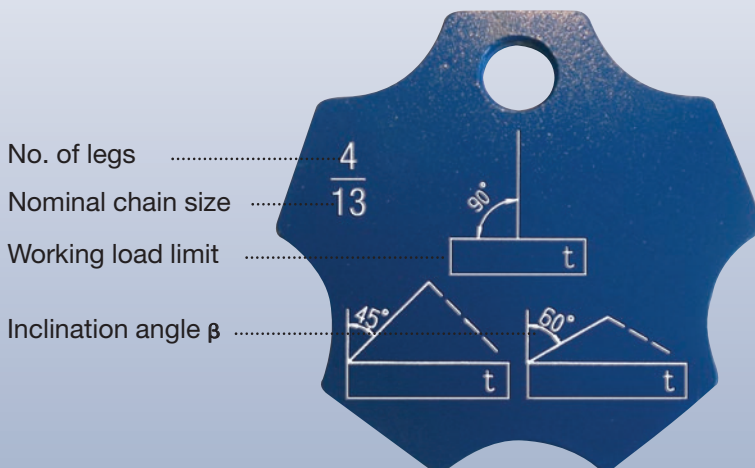

Legal Marking of Grade 100 Chains by the German DGUV

The number 4 under the \mathcal{H} represents a registration number of the German statutory accident insurance (DGUV) and helps to identify/locate the manufacturer in case of damage. The marking is also recognized by all international certification societies as well as by work authorities etc., among others the A. I. B. in Brussels.



Liability, Assembly, Material



From the DGUV-approved Round Steel Link Chains and Components **XL-400** are stamped with »**10**«, »XL-400«, »Germany« and a traceability code.

Round Steel Link Chains **XL-200** are stamped with »T3-10«, »XL-200«, »Germany« and traceability code.

TA10-chains are only allowed to couple with original **TA10**-Components of the corresponding Trade Size.

Liability

THIELE does not take any type of liability if **TA10**-Components are combined with other manufacturers' products.

Assembly

The combination of different Grades is prohibited.

Only use original THIELE spare parts.

Material

For the production of Grade **TA10**, only High Alloy Steels according to DIN 17115 are used.

Working Load Limit Tables

Working Load Limit – Type: Direct Slings

		1-Leg	2-Leg		3- and 4-Leg	
Inclination Angle		$\beta = 0^\circ$	$0^\circ < \beta \leq 45^\circ$	$45^\circ < \beta \leq 60^\circ$	$0^\circ < \beta \leq 45^\circ$	$45^\circ < \beta \leq 60^\circ$
Load Factor		1	1,4	1	2,1	1,5
Trade Size	Nominal Size [mm]	[t max.]	[t max.]	[t max.]	[t max.]	[t max.]
6-10	6	1,40	2,00	1,40	3,00	2,12
8-10	8	2,50	3,55	2,50	5,30	3,75
10-10	10	4,00	5,60	4,00	8,00	6,00
13-10	13	6,70	9,00	6,70	14,00	10,00
16-10	16	10,00	14,00	10,00	21,20	15,00
20-10*	20	16,00	22,40	16,00	33,50	23,60
22-10	22	19,00	26,50	19,00	40,00	28,00
26-10*	26	26,50	37,50	26,50	56,00	40,00
32-10*	32	40,00	56,00	40,00	85,00	60,00



Note: THIELE chain slings are available in mounted and welded execution.

Table 1

*These chain slings are only available in welded execution.

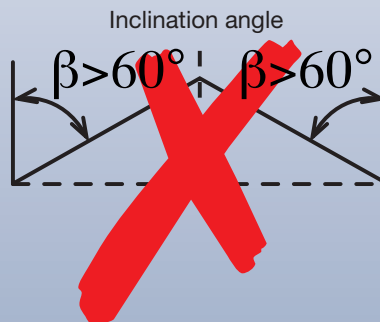

Safety Notice:

Can fail if damaged, misused or overloaded. Inspect before use. Use only if trained. Observe rated capacity in tables 1, 2, 3. DEATH or INJURY can occur from improper use or maintenance.



Working Load Limit Tables

Working Load Limit – Type: Choke Hitch

		1-Leg	2-Leg	3- and 4-Leg
Inclination Angle β		$\beta = 0^\circ$	$0^\circ < \beta \leq 45^\circ$	$45^\circ < \beta \leq 60^\circ$
Load Factor		0,8	1,12	0,8
Trade Size	Nominal Size [mm]	[t max.]	[t max.]	[t max.]
6-10	6	1,12	1,60	1,12
8-10	8	2,00	2,80	2,00
10-10	10	3,15	4,50	3,15
13-10	13	5,30	7,50	5,30
16-10	16	8,00	11,20	8,00
20-10	20	12,50	18,00	12,50
22-10	22	15,00	21,20	15,00
26-10	26	21,20	30,00	21,20
32-10	32	31,50	45,00	31,50

Note: Inclination angles β over 60° are prohibited.

Table 2

Working Load Limit – Type: Endless Chain

		K11		K12	K13	K22	K23
Inclination Angle β		$\beta = 0^\circ$	$0^\circ < \beta \leq 25^\circ$	$0^\circ < \beta \leq 45^\circ$	$45^\circ < \beta \leq 60^\circ$	$0^\circ < \beta \leq 45^\circ$	$45^\circ < \beta \leq 60^\circ$
Load Factor		1,6	1,45	1,12	0,8	1,7	1,2
Trade Size	Nominal Size [mm]	[t max]	[t max]	[t max.]	[t max.]	[t max.]	[t max.]
6-10	6	2,24	2,00	1,60	1,12	2,36	1,70
8-10	8	4,00	3,55	2,80	2,00	4,25	3,00
10-10	10	6,30	5,60	4,50	3,15	6,70	4,75
13-10	13	10,60	9,50	7,50	5,30	11,20	8,00
16-10	16	16,00	14,00	11,20	8,00	17,00	11,80
20-10	20	25,00	22,40	18,00	12,50	26,50	19,00
22-10	22	30,00	28,00	21,20	15,00	31,50	22,40
26-10	26	42,50	37,50	30,00	21,20	45,00	31,50
32-10	32	63,00	56,00	45,00	31,50	67,00	47,50

Note: Inclination angles β over 60° are prohibited.

Table 3



Type of Endless Chains

Type K11



Type K12

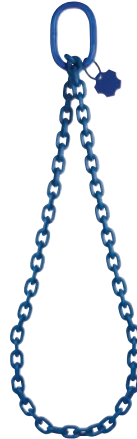

Type K22

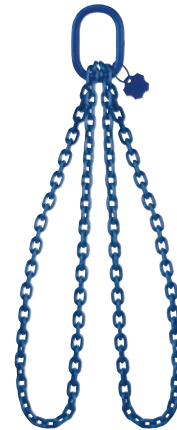

Load Reductions

Temperature Application Range

Round Steel Link Chains **XL-200** (acc. to ASTM 973)

Temperature Application Range	W.L.L.
-20°C to 205°C	100 %

Round Steel Link Chains **XL-400** (acc. to PAS 1061)

Temperature Application Range	W.L.L.
-30°C to 200°C	100 %
over 200°C to 300°C	90 %
over 300°C to 380°C	60 %

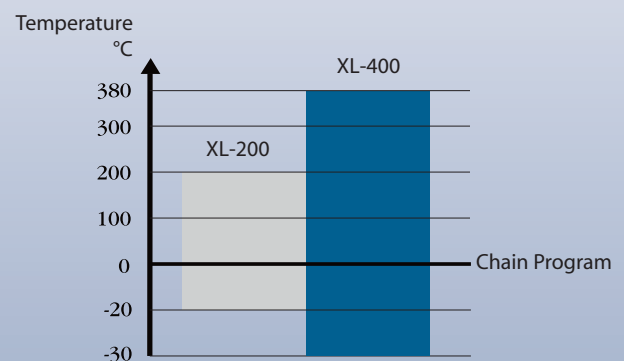

Load Factor at Asymmetry

No. of Legs	1		2		3		4			
	Inclination Angle β	Load Factor	Inclination Angle β	Load Factor	Inclination Angle β	Load Factor	Inclination Angle β	Load Factor		
	-	1	0° – 45°	1	46° – 60°	1	0° – 45°	1,4	46° – 60°	1

Table 4



DISTRIBUIDOR
AUTORIZADO

MEX (55) 53 63 23 31
QRO (442) 1 95 72 60

MTY (81) 83 54 10 18
ventas@industrialmagza.com



Product Features

Round Steel Link Chains TWN 1805 acc. to PAS 1061 **XL-400**



Trade Size	Article-No.	Nom. Size d [mm]	Pitch p [mm]	Pitch Tol. ± [mm]	Inside Width w ₁ [mm min.]	Outside Width w ₂ [mm max.]	Working Load Limit [t max.]	Weight app. [kgs/m]
6-10	F01610B	6	18	0,5	7,80	22,20	1,40	0,9
8-10	F01615B	8	24	0,7	10,92	29,60	2,50	1,6
10-10	F01622B	10	30	0,9	13,00	37,00	4,00	2,5
13-10	F01629B	13	39	1,2	17,48	48,10	6,70	4,3
16-10	F01635B	16	48	1,4	20,80	59,20	10,00	6,5
20-10	F01638B	20	60	1,8	26,00	74,00	16,00	10,1
22-10	F01650B	22	66	2,0	28,60	81,40	19,00	12,3
26-10	F01660B	26	78	2,3	33,80	96,20	26,50	17,1
32-10	F01670B	32	96	2,9	41,60	118,40	40,00	23,0

New

Coated with environmentally friendly AQUA-chain lacquer (RAL 5002).





Round Steel Link Chains TWN 0072 acc. to ASTM 973 **XL-200**

Trade Size	Article-No.	Nom. Size d [mm]	Pitch p [mm]	Pitch Tol. ± [mm]	Inside Width w ₁ [mm min.]	Outside Width w ₂ [mm max.]	Working Load Limit [t max.]	Weight app. [kgs/m]
6-10	F01616	6	18	0,5	7,95	22,20	1,40	0,9
7-10	F01621	7	21	0,7	9,53	25,90	2,00	1,2
8-10	F01617	8	24	0,7	10,92	29,60	2,60	1,6
10-10	F01618	10	30	0,9	13,00	37,00	4,00	2,5
13-10	F01619	13	39	1,2	17,48	48,10	6,80	4,1
16-10	F01620	16	48	1,4	20,63	59,20	10,30	6,2



Coated with environmentally friendly AQUA-chain lacquer (RAL 7011).

Comparison between Round Steel Link Chains **XL-400** and **XL-200**

Properties	Chain Type	XL-400	XL-200
Standard		PAS 1061	ASTM 973
Material		higher alloyed steel	alloyed steel
Temperature application range		-30°C up to 380°C; reduction starting from 200°C	-20°C up to 205°C
Working Load Limit (WLL)		25% higher than Grade 80	25% higher than Grade 80
Manufacturers Proof Force (MPF)		min. 2,5 x WLL	min. 2 x WLL
Breaking Force (BF)		min. 4 x WLL; up to 7% reduction allowed	min. 4 x WLL
Elongation at break (completed finish)		min. 20%	min. 20%
Charpy Notch Value		min. 42J at -20°C	min. 36J at -20°C
Deflection		min. 0,8 x d	min. 0,8 x d
Fatigue		min. 20.000 LC	no requirements
Material properties (stress corrosion)		according to standard	no requirements
Finish		Galvanizing prohibited	Galvanizing prohibited
Colour (solvent-free)		RAL 5002	RAL 7011
Marking		Ⓢ -10, XL-400, Germany, ID#	T3-10, XL-200, Germany, ID#
Certification		DGUV	THIELE



Suspension Components

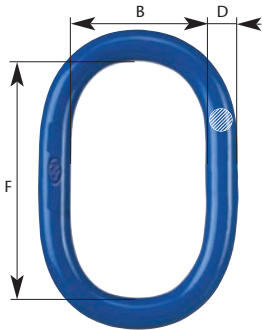

New

The Master Link Form A TWN 1813

according to DIN 5688 for 1- and 2-leg chain slings enables an easy assembly of a connecting link **XL-LOK**® TWN 1820. This way of coupling offers a higher flexibility in assembling of chain slings with the advantage of less stock inventory. Further on, the links acc. to EN 1677-4 may be used as components e.g. on steel wire rope slings acc. to DIN EN 13414-1.

Trade Size		Article-No.	Working Load Limit [t max.]	Dimensions [mm]			Weight app. [kgs]
1-Leg	2-Leg			D	F	B	
6 (7)	6	F1813013	2,50	13	90	50	0,30
8	(7)	F1813016	4,00	16	110	60	0,50
10	8	F1813018	5,00	18	130	70	0,79
-	10	F1813020	6,00	20	140	80	1,24
13	-	F1813022	7,10	22	160	90	1,50
16	13	F1813026	10,00	26	180	100	2,33
18	16	F1813032	15,00	32	230	125	4,40
22	18	F1813036	20,00	36	250	140	6,20
-	20	F1813040	23,60	40	290	160	8,80
26	22	F1813045	30,00	45	320	175	12,00
32	26	F1813050	40,00	50	340	190	16,00
-	-	F1813056	50,00	56	380	210	23,00
-	32	F1813063	60,00	63	430	240	33,00
-	-	F1813070	75,00	70	470	260	44,00

Note: The TWN 1813 replaces the TWN 1807 and TWN 1808.
 Rated for 2-leg chain slings use with inclination angle $0^\circ < \beta \leq 45^\circ$.

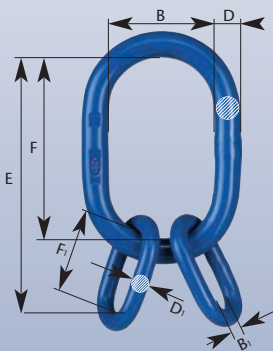

New

The Master Link Assembly TWN 1814

according to DIN 5688 for 3- and 4-leg chain slings enables easy assembling of a **XL-LOK**® TWN 1820. Further on, the links acc. to EN 1677-4 may be used as components e.g. on steel wire rope slings acc. to DIN EN 13414-1.

Trade Size	Article-No.	Working Load Limit $0^\circ < \beta \leq 45^\circ$ [t max.]	Dimensions [mm]							Weight app. [kgs]
			E	D	F	B	D ₁	F ₁	B ₁	
6-10	F1814016	4,00	170	16	110	60	13	60	30	1,00
8-10	F1814020	6,00	210	20	140	80	16	70	35	1,80
10-10	F1814026	10,00	270	26	180	100	20	90	45	3,80
13-10	F1814032	15,00	350	32	230	125	26	120	60	7,70
16-10	F1814040	23,60	420	40	290	160	28	130	65	13,00
22-10	F1814050	40,00	520	50	340	190	40	180	90	28,00
26-10	F1814063	60,00	630	63	430	240	45	200	100	49,00
32-10	F1814080	85,00	740	80	520	290	50	220	110	86,00

Note: The TWN 1814 replaces the TWN 1809.

Suspension Components

The **Master Link Assembly TWN 1815**

according to EN 13414-1 is designed for 3- and 4-leg wire rope slings. Dimensionally the links comply with the DIN 5688-3. The fracture mechanics are according to EN 1677-1 and EN 1677-2.

The special enlarged intermediate links enable a simple assembly of steel and fiber wire rope slings.

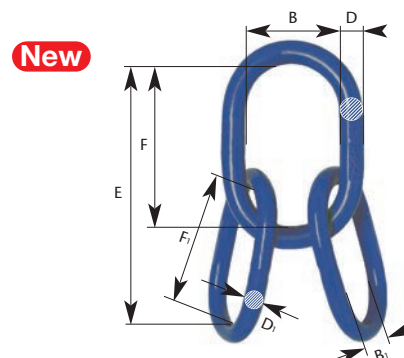

Article-No.	Working Load Limit 0° $\beta \leq 45^\circ$ [t max.]	Dimensions [mm]							Categorization of the Wire Rope Diameter*		Weight app. [kgs]
		E	D	F	B	D ₁	F ₁	B ₁	Fiber Rope [mm]	Steel Rope [mm]	
F1815016	3,50	200	16	110	60	13	90	50	12,00	11,00	1,10
F1815018	5,00	240	18	130	70	16	110	60	14,00	14,00	1,90
F1815022	6,00	290	22	160	90	18	130	70	16,00	16,00	3,10
F1815026	9,30	340	26	180	100	22	160	90	20,00	18,00	5,30
F1815032	13,90	410	32	230	125	26	180	100	24,00	22,00	9,00
F1815036	20,00	480	36	250	140	32	230	125	28,00	28,00	15,00
F1815045	26,30	570	45	320	175	36	250	140	32,00	32,00	24,00
F1815050	40,00	660	50	340	190	45	320	175	40,00	40,00	40,00
F1815056	50,20	720	56	380	210	50	340	190	44,00	44,00	55,00
F1815063	62,60	810	63	430	240	56	380	210	52,00	48,00	79,00
F1815085	127,20	1040	85	520	290	80	520	290	60,00	60,00	200,00

*According to DIN EN 13414-1 for 3- and 4-leg wire rope slings.

The **Intermediate Master Link Type B TWN 1795**

according to DIN 5688-3 enables assembling of a **XL-LOK**® and other components. The working load limit as well as the manufacturers' and proof requirements are based on the standard DIN EN 1677-1 and DIN EN 1677-4 considering a 25% higher working load limit.

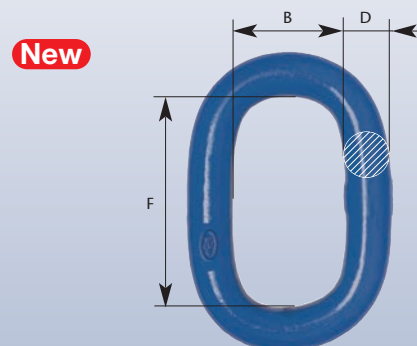

Trade Size	Article-No.	Working Load Limit [t max.]	Dimensions [mm]			Weight app. [kgs]
			D	F	B	
B8	F179508	1,40	8	36	18	0,05
B10	F179510	2,50	10	46	23	0,09
B13	F179513	4,00	13	60	30	0,20
B16	F179516	6,70	16	70	35	0,36
B20	F179520	10,00	20	90	45	0,73
B22	F179522	12,50	22	100	50	0,97
B26	F179526	16,00	26	120	60	1,60
B28	F179528	19,00	28	130	65	1,90
B32	F179532	26,50	32	140	70	2,90
B36	F179536	31,30	36	160	80	4,20
B40	F179540	40,00	40	180	90	5,80
B45	F179545	50,00	45	200	100	8,20



Suspension Components



The Fixed Size Master Link Assembly TWN 1810/1

Type TAA1 for 1-leg chain slings is automatically determined to the trade size of the ringshackle. The ringshackle moves freely. A welded identification tag contains all the necessary data required. The dimensions are in accordance with DIN 5688, form A. The fixed size master link assembly type TAA1 can also be delivered without the ringshackle as a master link TWN 1813.

Trade Size	Article-No.	Working Load Limit [t max.]	Dimensions [mm]				Suitable for Crane Hooks acc. DIN 15401 [No.]	Weight app. [kgs]
			E	D	F	B		
6-10	F1810106	1,40	121	13	90	50	1,6	0,40
8-10	F1810108	2,50	147	16	110	60	2,5	0,71
10-10	F1810110	4,00	176	18	130	70	4	1,21
13-10	F1810113	6,70	219	20	140	80	6	2,33
16-10	F1810116	10,00	256	22	160	90	8	3,90



The Fixed Size Master Link Assembly TWN 1810/2

Type TAA2 for 2-leg chain slings is automatically determined to the trade size of the ringshackle. The ringshackle moves freely. A welded identification tag contains all the necessary data required. The dimensions are in accordance with DIN 5688, form A. The fixed size master link assembly type TAA2 can also be delivered without the ringshackle as a master link TWN 1813.

Trade Size	Article-No.	Working Load Limit $0^\circ < \beta \leq 45^\circ$ [t max.]	Dimensions [mm]				Suitable for Crane Hooks acc. DIN 15401 [No.]	Weight app. [kgs]
			E	D	F	B		
6-10	F1810206	2,00	121	13	90	50	1,6	0,50
8-10	F1810208	3,55	167	18	130	70	4	1,20
10-10	F1810210	5,60	186	20	140	80	5	1,90
13-10	F1810213	9,00	239	26	180	100	8	4,00
16-10	F1810216	14,00	296	32	230	125	12	7,60

Suspension Components

The Fixed Size Master Link Assembly TWN 1810/4

Type TAA4 for 3/4-leg chain slings is automatically determined to the trade size of the ringshackle. The ringshackle moves freely. A welded identification tag contains all the necessary data required. The dimensions are in accordance with DIN 5688, form A. The fixed size master link assembly type TAA4 can also be delivered without the ringshackle as a master link TWN 1814.

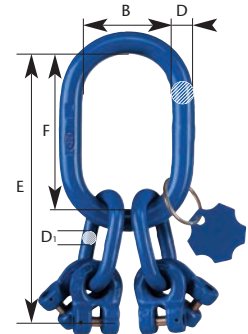

Trade Size	Article-No.	Working Load Limit $0^\circ < \beta \leq 45^\circ$ [t max.]	Dimensions [mm]					Suitable for Crane Hooks acc. DIN 15401 [No.]	Weight app. [kgs]
			E	D	F	B	D ₁		
6-10	F1810406	3,00	201	16	110	60	13	2,5	1,40
8-10	F1810408	5,30	247	20	140	80	16	5	2,70
10-10	F1810410	8,00	316	26	180	100	20	8	5,40
13-10	F1810413	14,00	409	32	230	125	26	12	11,20
16-10	F1810416	21,20	495	40	290	160	28	20	19,40





Suspension Components

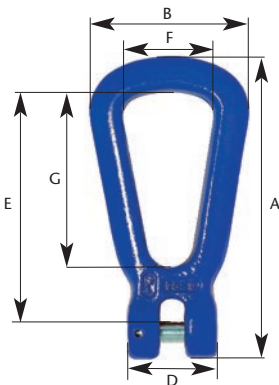

New The **Master Link with Pin Coupling TWN 1819** is suitable to be used for single leg slings for bundling of e.g. rod material. The compact design enables an easy handling. The special shape makes the THIELE-original unique.

100% magnetic crack-tested.

DGUV-approved.

Trade Size	Article-No.	Working Load Limit [t max.]	Dimensions [mm]								Weight app. [kgs]
			A	B	C	D	E	F	G	H	
13-10	F31025	6.70	189	102	32	60	142,5	60	110	22	1,09

XL-LOK® Connector

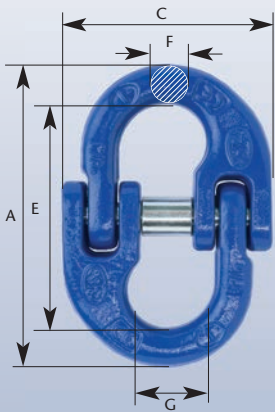

Connecting Link **XL-LOK® TWN 1820**

XL-LOK® Connecting Links according to THIELE plant standard (TWN) are designated for safe lifting, moving and slinging of weights. Working load limits and product requirements are based on the EN 1677-1, taking a 25% higher working load limit into account. Spare parts are available according to TWN 1921.

100% magnetic crack-tested.

DGUV-approved.

Trade Size	Article-No.	Working Load Limit [t max.]	Dimensions [mm]					Weight app. [kgs]
			E	G	A	C	F	
6-10	F30807	1,40	45,0	14,0	61,0	38,5	7,6	0,07
8-10	F30817	2,50	62,0	19,0	85,0	55,0	10,0	0,20
10-10	F30827	4,00	72,0	23,8	97,2	65,5	12,6	0,35
13-10	F30837	6,70	87,3	28,0	125,3	82,5	16,7	0,74
16-10	F30847	10,00	105,0	34,3	146,2	109,0	20,6	1,16
22-10	F30861	19,00	140,0	47,3	193,0	132,5	26,0	3,30

New

Hooks

The Eye Self-Locking Hook TWN 1836

automatically locks at load. The flattened extra large eye offers universal coupling options. A robust trigger at the back side of the hook can be easily hand-operated. Despite an extra wide hook-opening, the eye self-locking hooks offer a slim shape and enable a versatile use. The special shape makes the THIELE-original unique.

The available trigger sets are universal for hooks type TWN 1836 and 1837.

100% magnetic crack-tested.

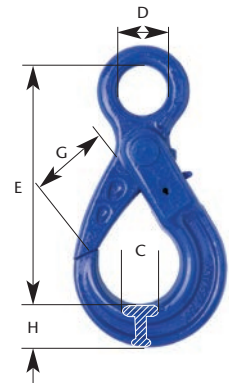

Trade Size	Article-No.	Working Load Limit [t max.]	Dimensions [mm]					Weight app. [kgs]
			E	D	G	H	C	
6-10	F092203	1,40	110	21	28	20	15	0,50
8-10	F092213	2,50	137	27	35,5	26	20	0,80
10-10	F092223	4,00	169	34,5	45	30	26	1,50
13-10	F092233	6,70	209	40	53,5	40,5	32,5	3,00
16-10	F092243	10,00	254	50	62	50,5	38	6,00
New 22-10	F092273	19,00	319,5	70	80	66	52	11,74

The Clevis Self-Locking Hook TWN 1837

automatically locks at load. A robust trigger at the back side of the hook can be easily hand-operated. Despite an extra wide hook-opening, the clevis self-locking hooks offer a slim shape and enable a versatile use. The special shape makes the THIELE-original unique.

The available trigger sets are universal for Hooks type TWN 1836 and 1837.

100% magnetic crack-tested.

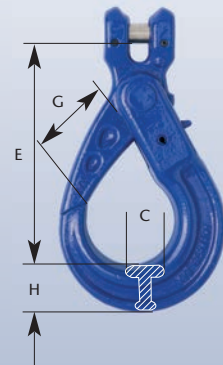

Trade Size	Article-No.	Working Load Limit [t max.]	Dimensions [mm]				Weight ca. [kgs]
			E	G	H	C	
6-10	F092002	1,40	96	28	20	15	0,50
8-10	F092012	2,50	123	35,5	26	20	0,90
10-10	F092022	4,00	144	45	30	26	1,50
13-10	F092032	6,70	182	53,5	40,5	32,5	3,00
16-10	F092042	10,00	217	62	50,5	38	5,90
New 22-10	F092072	19,00	276,5	80	66	52	12,31



Hooks

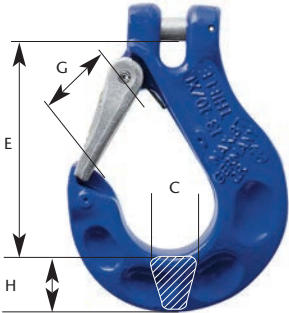

The Clevis Sling Hook TWN 1840/1

with its heavy-duty forged safety latch and its clevis is designed to the corresponding trade size. The forged measurement points and maximum admissible values allow an easy inspection of the hook-opening. The safety latch is protected by wear edges on the hook body. Additionally, the safety latch has a fixed position due to the forged seat at the tip of the hook. The special shape makes the THIELE-original unique.

100% magnetic crack-tested.

DGUV-approved.

Trade Size	Article-No.	Working Load Limit [t max.]	Dimensions [mm]				Weight app. [kgs]
			E	G	H	C	
6-10	F336050	1,40	75	24	20	17	0,36
8-10	F336150	2,50	92	30	25	22	0,75
10-10	F336250	4,00	113	37	32	28	1,40
13-10	F336350	6,70	133	42	41	35	2,50
16-10	F336450	10,00	162	51	50	41	4,40

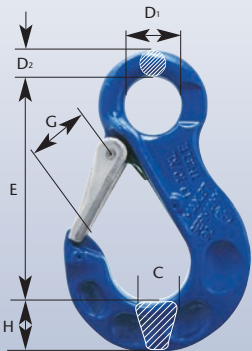

The Eye Sling Hook TWN 1841/1

with its heavy-duty forged safety latch and its eye is designed to the corresponding trade size. The flattened extra large eye offers universal coupling options. The forged measurement points and maximum admissible values allow an easy inspection of the hook-opening. The safety latch is protected by wear edges on the hook body. Additionally, the safety latch has a fixed position due to the forged seat at the tip of the hook. The special shape makes the THIELE-original unique.

100% magnetic crack-tested.

DGUV-approved.

Trade Size	Article-No.	Working Load Limit [t max.]	Dimensions [mm]						Weight app. [kgs]
			E	D ₁	D ₂	G	H	C	
6-10	F32905	1,40	91	21	11	24	20	17	0,36
8-10	F32915	2,50	118	28	14	30	25	22	0,78
10-10	F32925	4,00	145	36	18	37	32	28	1,50
13-10	F32935	6,70	168	42	21	42	41	35	2,55
16-10	F32945	10,00	210	54	25	51	50	41	4,65
22-10	F32975	19,00	271	65	30	70	62	54	9,77
26-10	F32985	26,50	302	70	33	75	71	59	14,20 New

Hooks

The Eye Foundry Hook TWN 1856

has been optimized in its shape. Working load limits and product requirements are based on the EN 1677-1, taking a 25 % higher Working load limit into account. The special shape makes the THIELE-original unique.

100% magnetic crack-tested.

DGUV-approved.

New

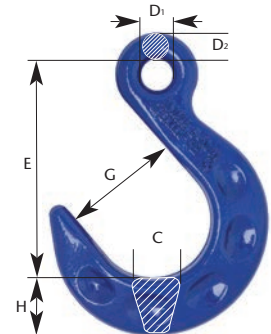

Trade Size	Article-No.	Working Load Limit [t max.]	Dimensions [mm]						Weight app. [kgs]
			E	D ₁	D ₂	G	H	C	
6-10*	F32355	1,40	95	21	12	50	25,1	19,5	0,42
8-10	F32365	2,50	125	28	14,5	66	33	26	0,92
10-10*	F32375	4,00	146	32	16	76	35,1	32	1,47
13-10*	F32385	6,70	175	42	21	89	41	38	3,15
16-10*	F32395	10,00	205	54	23	102	48	35	5,41
22-10*	F32413	15,00	265	65	29,5	127	70	65	11,40

*In development.

Shortening Components

The Clevis Shortening Hook TWN 1827

complies with DIN 5692. It makes the lifting of loads safer due to a system check which means that the shortening hook fulfills the test requirements assembled into the chain. The new shape of the shortening hooks TWN 1827 offer you much more safety than with conventional shortening hooks. The extra wide chain attachment guarantees a special firm seating of the inserted chain link and it is also protected from damage at the same time.

With our new TWN 1827 shortening hook, we are offering you grade 100 perfection continued with a long service-life of your slinging equipment.

100% magnetic crack-tested.

DGUV-approved.

New

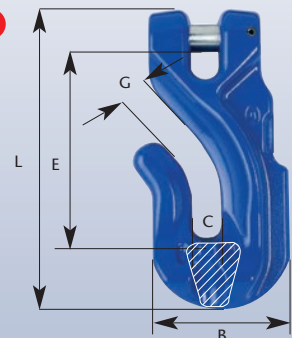

Trade Size	Article-No.	Working Load Limit [t max.]	Dimensions [mm]					Weight app. [kgs]
			E	D	L	B	C	
6-10*	F33194	1,40	-	-	-	-	-	-
8-10	F33204	2,50	71	9,5	110	55	34	0,51
10-10*	F33214	4,00	83	12,5	132	69	42	0,95
13-10*	F33224	6,70	109	15,5	168	79	54	1,76
16-10*	F33234	10,00	-	-	-	-	-	-

*In development.



Shortening Components

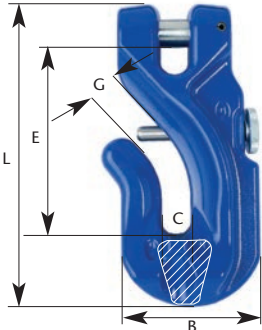

New The **Clevis Shortening Hook with Safety Pin TWN 1827/1** complies with DIN 5692 makes the lifting of loads safer due to a system inspection which means that the shortening hook fulfills the test requirements assembled into the chain. The new shape of the shortening hooks TWN 1827 offers you much more safety than with conventional shortening hooks. The extra wide chain attachment enables us to guarantee you an especially firm seating of the inserted chain link and it is also protected from damage at the same time. The locking pin prevents an accidental loosening of the sling chain. The special shape makes the THIELE-original unique.

With our new TWN 1827/1 shortening hook, we are offering you Grade 100 perfection combined with a long service-life of your slinging equipment.

100% magnetic crack-tested.

DGUV-approved.

Trade Size	Article-No.	Working Load Limit [t max.]	Dimensions [mm]					Weight app. [kgs]
			E	G	L	B	C	
6-10*	F33195	1,40	-	-	-	-	-	-
8-10	F33205	2,50	71	9,5	110	55	34	0,51
10-10	F33215	4,00	83	12,5	132	67	42	0,95
13-10	F33225	6,70	109	15,5	168	79	54	1,76
16-10*	F33235	10,00	-	-	-	-	-	-

*In development.

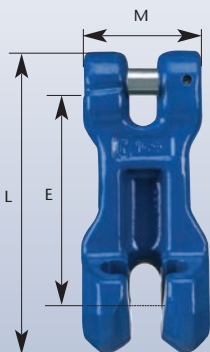

The **Clevis Shortening Claw TWN 1851**

proven over many decades from the grade 80-program, has been further developed into the grade 100. The clevis is designed to the corresponding trade size. The chain has a safe seat in the claw pocket in order to avoid release at any time.

100% magnetic crack-tested.

Trade Size	Article-No.	Working Load Limit [t max.]	Dimensions [mm]			Weight app. [kgs]
			E	L	M	
6-10	F34904	1,40	54	81	32	0,21
8-10	F34924	2,50	80	115	46	0,61
10-10	F34934	4,00	90	134	56	0,96
13-10	F34944	6,70	117	175	72	2,00
16-10	F34954	10,00	144	214	86	3,57



Shortening Components

The **RAPID-Shortening Claw TWN 1852**

can be assembled and disassembled fast and easily with no additional tools. The ergonomic and compact design enables its positioning at any place on the chain. Two robust locking devices avoid the unsafe release of the chain in a loaded or unloaded condition. The locking device is equipped with a robust spring system.

100% magnetic crack-tested.

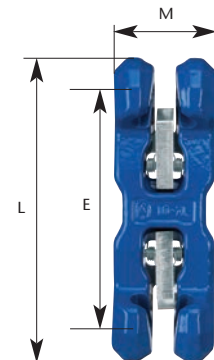

Trade Size	Article-No.	Working Load Limit [t max.]	Dimensions [mm]			Weight app. [kgs]
			E	L	M	
8-10	F34775	2,5	111	148	48	0,79
10-10	F34780	4,0	134	180	60	1,97
13-10	F34785	6,7	179	240	78	2,70
16-10	F34790	10,0	222	296	96	9,00



Shortening Components

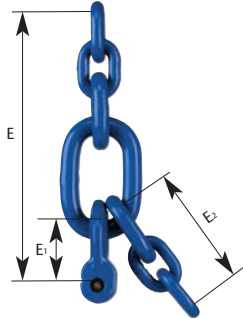

The Fixed Size Shortening Device TWN 1896

is the only one in the world that completes the grade 100 assembly system and is automatically attached to the trade size by a ringshackle. Therefore, it avoids the possibility of malfunction and provides additional safety for the user.

Trade Size	Article-No.	Working Load Limit [t max.]	Dimensions [mm]						Weight app. [kgs]
			E	E ₁	E ₂	B-Link			
6-10	F189606	1,4	137	31	60	10	46	23	0,32
8-10	F189608	2,5	175	38	78	13	60	30	0,70
10-10	F189610	4,0	215	46	99	16	70	35	1,40
13-10	F189613	6,7	270	59	126	18	85	40	2,60
16-10	F189616	10,0	326	76	150	22	100	50	5,00

Shackles

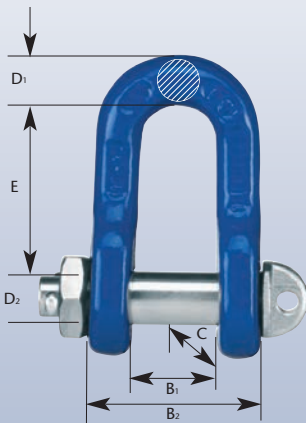

The Bolt Shackle Type C TWN 1871

is dimensionally in accordance with DIN 82101. It is supplied with galvanized bolt, nut and cotter pin.

100% magnetic crack-tested.

DGUV-approved.

Trade Size	Article-No.	Working Load Limit [t max.]	Dimensions [mm]						Weight app. [kgs]
			E	D ₁	D ₂	C	B ₁	B ₂	
10-10	F303100	4,0	49	15	16	32	21	47	0,45
13-10	F303200	6,7	61	19	20	40	27	61	0,84
16-10	F303300	10,0	73	23	24	48	33	75	1,41
New 22-10	F303500	19,0	111	33	36	72	47	107	4,59



Chain Tensioners

The Chain Tensioner with Spindle TWN 1454

is designed in accordance to standard EN 12195-3 and EN 1677-1. In combination with other lashing and connecting components, it is mainly used in lashing chains for the securing of loads in all industry sectors. Additionally, it is suitable for overhead lifting purposes.

The tensioners achieve a high pre-tension force with less effort because of the screw transmission. This feature is important for tying down, because only the pretension force contributes to the securing of loads.

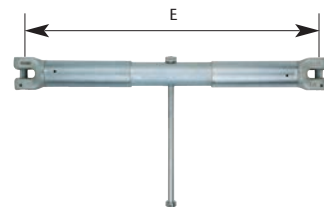

Additional features:

- + A practical dimensioned tensioning hub
- + Protected screw spindle located inside
- + Robust protection tubes
- + Integrated turn-off locking mechanism
- + Clevis type connection on both ends allows easy assembly of the corresponding round steel link chain.
- + The length of the handle is dimensioned according to EN 12195-3 (ergonomic aspect: Maximum hand pulling force is limited to 500N)
- + Finish: electro galvanized and yellow chromated

Trade Size	Article-No.	Norm. straight load (S _{TF}) [daN min.]	Tensioner under straight load [daN max.]	Dimensions [mm]			Weight app. [kgs]
				E _{max}	E _{min}	Hub	
13-10	F341877	2.600	13.000	675	445	230	7,20
16-10	F341977	3.100	20.000	834	554	280	11,80

Note: Also suitable for lifting!





Chain Tensioners

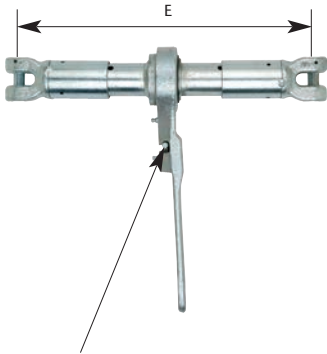

Note: The life time of the chain tensioner with ratchet may be considerably extended by regular lubrication at the greasing nipple.

The Chain Tensioner with Ratchet TWN 1455

is designed in accordance with standard EN 12195-3 and EN 1677-1. Together with other lashing and connecting components, they are mainly used in lashing chains for the securing of loads in all industry sectors. Additionally, they are suitable for overhead lifting purposes.

The ratchet tensioners achieve a high pre-tension force with less effort because of the screw transmission. This feature is important for tying down because only the pretension force contributes to the securing of loads.

Additional features:

- + A practical dimensioned tensioning hub
- + Protected screw spindle located inside
- + Robust protection tubes
- + Integrated turn-off locking mechanism
- + Clevis type connection on both ends allows easy assembly of the corresponding round steel link chain.
- + The length of the handle is dimensioned according to EN 12195-3 (ergonomic aspect: Maximum hand pulling force is limited to 500N)
- + Finish: electro galvanized and yellow chromated

Trade Size	Article-No.	Norm. straight load (S _{TF}) [daN min.]	Tensioner under straight load [daN max.]	Dimensions [mm]			Weight app. [kgs]
				E _{max}	E _{min}	Hub	
13-10	F341878	2.600	13.000	675	445	230	8,40
16-10	F341978	3.100	20.000	834	554	280	13,50

Note: Also suitable for lifting!





Special Sling Components

The **Skip Suspension Link for one-hand use TWN 1869** is a further development of the Grade 80 Skip Suspension Link TWN 0869. The locking device is located in a way that the suspension link can be assembled and disassembled one-handed easily at the container cones.

New

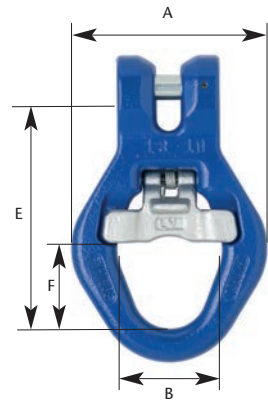

Trade Size	Article-No.	Working Load Limit [t max.]	Dimensions [mm]				Weight app. [kgs]
			E	F	B	A	
13-10	F313805	6,70	142	57,5	65	122	1,92





Special Sling Components

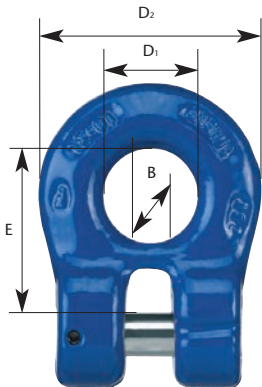

The forged **Ringshackle TWN 1812**

is automatically attached to the corresponding trade size. It can be used as a lower terminal in the chain sling and be connected to a clevis lashing point. A coupling with a **XL-LOK®** is possible.

100% magnetic crack-tested.

DGUV-approved.

Trade Size	Article-No.	Working Load Limit [t max.]	Dimensions [mm]				Weight app. [kgs]
			E	D ₁	D ₂	B	
6-10	F31704	1,40	31	17	39	8	0,10
8-10	F31714	2,50	37	21	50	11	0,20
10-10	F31724	4,00	46	26	62	14	0,39
13-10	F31734	6,70	59	33	79	18	0,83
16-10	F31744	10,00	75	42	100	23	1,59

Lashing Chains



The **Lashing Chain with Spindle Tensioner TWN 1410**

with standard length L = 3.500 mm with extended tensioner and unshortened chain complies with DIN EN 12195-3.

The length adjustment is achieved by the shortening device and the tensioner. All lengths are available upon request.

Trade Size	Article-No.	Lashing Capacity (LC) under straight load [kN max.]	Weight app. [kgs]
13-10	F34183	130	21,63
16-10	F34184	200	39,35



Lashing Chains

The Lashing Chain with Ratchet TWN 1411

with standard length L = 3.500 mm with extended tensioner and unshortened chain complies with DIN EN 12195-3.

The length adjustment is achieved by the shortening device and the tensioner. All lengths are available upon request.



Trade Size	Article-No.	Lashing Capacity (LC) under straight load [kN max.]	Weight app. [kgs]
13-10	F34183R	130	23,00
16-10	F34184R	200	41,00

Spare Parts and Accessories

All Spare Parts are only available as sets!

Chain Card File TWN 0944

Form to file the regular inspections according to EN-regulations.

Article-No. Z04575



Assembly Set TWN 0945

Consisting of 6 punches in a plastic holder to disassemble chains from components.

The complete set covers all trade sizes for the use with the THIELE-Sling-Assembly-System.

Article-No. Z03303

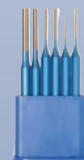

Tensioning Tag TWN 1402

Tag for lashing chains acc. to EN 12195-3.

Article-No. Z07264





Spare Parts and Accessories

Spare Parts TWN 1904/0

for Clevis Type Hooks (Bolt and Spiral Pin)

Trade Size	Article-No.	Packing Units	Weight app. [kgs]	
6-10	F48686	1 set	0,01	 <p>Load Pin for Clevis Type Hooks</p>  <p>(TWN 1835/1, TWN 1840/1, TWN 1827/1, TWN 1851)</p>
8-10	F48687	1 set	0,01	
10-10	F48688	1 set	0,03	
13-10	F48689	1 set	0,07	
16-10	F48690	1 set	0,11	

Spare Parts TWN 1908/0

for Sling Hooks (Safety Latch, Spring and Spiral Pin)

Trade Size	Article-No.	Packing Units	Weight app. [kgs]	
6-10	F48731	1 set	0,03	 <p>Spare Part Set for Sling Hooks</p>    <p>(TWN 1835/1, TWN 1840/1, TWN 1841/1)</p>
8-10	F48733	1 set	0,06	
10-10	F48735	1 set	0,11	
13-10	F48737	1 set	0,19	
16-10	F48739	1 set	0,32	
22-10	F48745	1 set	0,88	



Spare Parts and Accessories

Spare Parts TWN 1921

for **XL-LOK®** (Bolt and Spiral Pin)

Trade Size	Article-No.	Packing Units	Weight app. [kgs]	
6-10	F486013	1 set	0,01	<p>Spare Part Set for XL-LOK® (Bolt and Spiral Pin)</p> <p>(TWN 1820)</p>
8-10	F486043	1 set	0,01	
10-10	F486073	1 set	0,03	
13-10	F486103	1 set	0,05	
16-10	F486133	1 set	0,12	
22-10	F486191	1 set	0,46	



Spare Parts TWN 1930/0

for C-Shackle TWN 1871 (Bolt, Nut and Cotter Pin)

Trade Size	Article-No.	Packing Units	Weight app. [kgs]	
10-10	F304510	1 set	0,13	<p>Spare Part Set for C-Shackles</p> <p>(TWN 1871)</p>
13-10	F304610	1 set	0,25	
16-10	F304710	1 set	0,36	



Spare Parts and Accessories

Spare Parts TWN 1931/0

for RAPID® Shortening Claw TWN 1852 (2 Retainers, 2 Springs and 2 Spiral Pins)

Trade Size	Article-No.	Packing Units	Weight app. [kgs]	
8-10	F48687	1 set	0,01	 <p>Trigger Set for RAPID® Shortening Claw</p>  <p>(TWN 1852)</p>
10-10	F48688	1 set	0,03	
13-10	F48689	1 set	0,07	
16-10	F48690	1 set	0,11	

Spare Parts TWN 1933/0

for Clevis Self-Locking Hook TWN 1837 (Load Pin, 2 Spiral Pins)

Trade Size	Article-No.	Packing Units	Weight app. [kgs]	
6-10	Z10118	1 set	0,01	 <p>Spare Parts for Shortening Hook</p>  <p>(TWN 1837)</p>
8-10	Z10119	1 set	0,02	
10-10	Z10120	1 set	0,04	
13-10	Z10121	1 set	0,08	
16-10	Z10122	1 set	0,16	
22-10	Z10125	1 set	0,46	

Trigger Set TWN 1935

for Self-Locking Hooks TWN 1836 and TWN 1837 (Retainer, Spring, Assembly Plastic Bush and Spiral Pin)

Trade Size	Article-No.	Packing Units	Weight app. [kgs]	
6-10	Z10110	1 set	0,02	 <p>Trigger Set for Self-Locking Hooks</p>   <p>(TWN 1836, TWN 1837)</p>
8-10	Z10111	1 set	0,04	
10-10	Z10112	1 set	0,05	
13-10	Z10113	1 set	0,18	
16-10	Z10114	1 set	0,19	
22-10	Z10117	1 set	0,25	

Spare Parts and Accessories

Spare Parts TWN 1950

for Shortening Hook TWN 1827/1 (Safety Bolt, Pressure Spring, Knurled Screw)

Trade Size	Article-No.	Packing Units	Weight app. [kgs]	
6-10	F483310	1 set	0,01	 <p>Spare Parts for Shortening Hook</p>  <p>(TWN 1827/1)</p>
8-10	F48330	1 set	0,01	
10-10	F48328	1 set	0,02	
13-10	F483290	1 set	0,03	
16-10	F48339	1 set	0,05	



Spare Parts TWN 1951

for Combi Quick Fastener TWN 1853 (2 Bolts and 2 Spiral Pins)

Trade Size	Article-No.	Packing Units	Weight app. [kgs]	
6-10	F486865	1 set	0,02	 <p>Spare Parts for Combi-Quick Fastener</p>  <p>(TWN 1853)</p>
8-10	F486875	1 set	0,04	
10-10	F486885	1 set	0,08	
13-10	F486895	1 set	0,17	
16-10	F486905	1 set	0,29	
22-10	F486935	1 set	0,71	

Identification Tag TWN 1940

for Chain Slings

Article.-No.	Type	Weight app. [kgs]	
F08052	without welded ring	0,10	 <p>(TWN 1940)</p>
F08053	with welded ring	0,10	



Spare Parts and Accessories

Chain Gauge TWN 1946

for Round Steel Link Chains

Article-No.	Trade Size	Weight app. [kgs]	
F01690	6-10	0,10	 <p>(TWN 1946)</p>
F01691	8-10	0,15	
F01692	10-10	0,20	
F01693	13-10	0,25	
F01694	16-10	0,30	

Spare Parts TWN 0968

for Skip Suspension Link TWN 1869 (Bolt and Spiral Pin)

Trade Size	Article-No.	Packing Units	Weight app. [kgs]	
13-10	F486741	1 set	0,09	 <p>Load Pin for Skip Suspension Link</p>  <p>(TWN 1869)</p>

Spare Parts TWN 0969

for Skip Suspension Link TWN 1869 (Safety Latch, Spring and 2 Spiral Pins)

Trade Size	Article-No.	Packing Units	Weight app. [kgs]	
13-10	F314081	1 set	0,20	 <p>Spare Set for Skip Suspension Link</p>  <p>(TWN 1869)</p>



Examples for Chain Slings

1-Leg Chain Slings with **XL-LOK**[®]-Coupling

TWN 1600



TWN 1601



TWN 1602



TWN 1603



TWN 1604





Examples for Chain Slings

2-Leg Chain Slings with **XL-LOK**[®]-Coupling

TWN 1650



TWN 1651



TWN 1652



TWN 1653

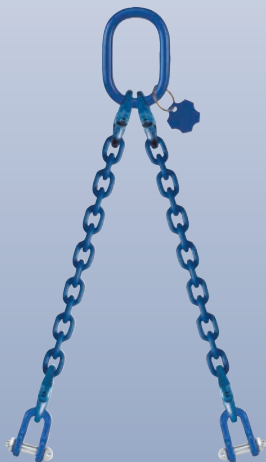

TWN 1654





Examples for Chain Slings

4-Leg Chain Slings with **XL-LOK**[®]-Coupling

TWN 1750



TWN 1751



TWN 1752



TWN 1753



TWN 1754





DISTRIBUIDOR
AUTORIZADO

MEX (55) 53 63 23 31
QRO (442) 1 95 72 60

MTY (81) 83 54 10 18
ventas@industrialmagza.com



Examples for Chain Slings

1-Leg Chain Slings, Fixed Size

TWN 1631



TWN 1632



2-Leg Chain Slings, Fixed Size

TWN 1681



TWN 1682





Examples for Chain Slings

4-Leg Chain Slings, Fixed Size

TWN 1781



TWN 1782





DISTRIBUIDOR
AUTORIZADO

MEX (55) 53 63 23 31
QRO (442) 1 95 72 60

MTY (81) 83 54 10 18
ventas@industrialmagza.com



Shortening Options





Endless Chains

Form K11

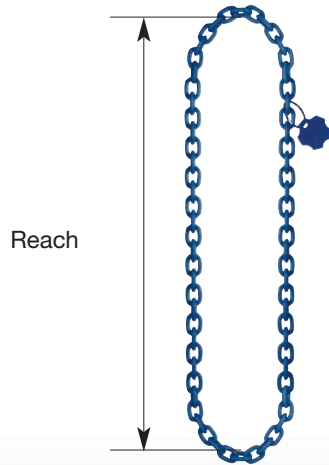

Circumference $\approx 2 \times$ Reach

Form K12



Form K22





Operation Manual

WARNING!

- Chain Slings and Components can only be used, if user instructions and operating instructions have been read carefully and are completely understood.
- The indicated values of loads on the I.D. tags must not be exceeded.
- Due to improper use, chains can fail.

IT'S A QUESTION OF YOUR SAFETY
Death or injury can occur from improper use or maintenance!

1. Transport and Storing

All products must be protected during transportation, use, and storage in severe weather conditions.

2. Before first use

Assembling, disassembling and using should only be accomplished by authorized persons according to DGUV-R 100-500, Chapter 2.8 (in Germany) Check the following points before using the chain sling for the first time:

- all test certificates exist (declaration of conformity, inspection certificate 3.1.B etc.); the chain sling you are going to use is the same that you ordered
- Chain slings and Lashing Chains are provided with the CE label
- identification and working load limit marked on the chain sling are identical to the corresponding information indicated on the test certificate; all details concerning the chain sling have been entered into the chain card file
- The assembly is prohibited until it has been found out that the machine in which should be built in, corresponds with the EC Directive for machines and its amendments (European rules and regulations).
- In suitable intervals, check the chain sling for damages or wear (depending upon severity of conditions slings shall be inspected for damage as frequently as prior to each lift. All supplied user instructions must be maintained and available for reference until the product is removed from service.

3. Warning and use advice

- EC Directive for Machines and its amendments as per 2006/42/EG
- Operation and use instructions for chain slings according to DIN 685 - Part 5, EN 818-6.
- Consult safety regulations for round Steel Link Chains used as slinging gear in hot dipped galvanizing plants (German rules and regulations) according to DGUV-R 109-004
- Consult Safety Regulations for Cranes according to DGUV52
- Consult load Suspension Devices for Lifting Operations (German rules and safety regulations) according to DGUV-R 100-500, Chapter 2.8
- Consult Safety certificate for riggers according to BGI 556
- Consult components for chain slings according to EN 1677-2
- Consult principles for test of industrial safety of lifting products
- Consult slinging of rod iron using steel round Steel Link Chains when loading and unloading sea-going ships
- Consult German rules and regulations VDI 2700-2701-2702

Special Sling Components, hooks and clutching devices should only be used in straight tensile direction

Especially forbidden is:

- the combination of different grades when assembling (except tongs)
- the using of chain slings which do not correspond to grade 100
- overloading
- To use a combination of products with different working load limits, unless the working load noted on the I.D. tag is based on the weakest component.
- the use of twisted or knotted chains
- to use bolts or wires to connect components
- to use deformed components, rigid or elongated chains
- to lift or pull loads with sharp edges without padding the edges
- to drive equipment over chain sling
- to multiple-wrap a chain around a loadhook or tension point
- to modify products by welding, burning, bending or other mechanical modifications
- to make inadmissible modifications, e.g. the use of a 2-leg chain sling with shortening hooks as a 4-leg chain sling
- to tip load a hook into a chain link
- to apply the load on the tip, side or back of the hook
- to load connectors (XL-LOK®) at one side
- to adjust chain links or products
- to adapt inclination over 60°
- to turn swivels or swivel hooks under load
- to weld transport ring screw type lifting eyes
- to exceed the indicated grip on lifting tongs
- the use of open or riveted repair links
- Galvanizing or hot dip-galvanized

It must be taken into consideration:

- the load to be lifted
- the free mobility of the hook's safety latches
- the use under chemical influences for example acids and steam is restricted or prohibited
- the influence of temperature on alloy chain and components
- shock load impacts the chain or fitting while lifting or securing
- any type of surface treatment to chain or fittings especially Galvanizing or hot dipped galvanizing can only be carried out by the manufacturer
- when lifting keep hands and other parts of body far away from the components
- be careful when locking hooks under load Danger of injury!
- when not in use chain slings shall be hung on a rack
- ensure free mobility of chain slings or other devices in the crane hook
- when using hooks without latches pay special attention to the position of the hook placement
- to the installation position
- if necessary protect screw tensioners by locking elements to prevent automatic unlocking
- load claws with chains only on the bottom of the pocket claws
- protect chain by padding or wrapping sharp edges
- Safety latches should not be obstructed when hooks are loaded
- in case of shortening hooks, load chains must be loaded in the bowl of the hook
- hook-openings must point away from the load being lifted
- that the hook-up point and lifting hooks are compatible
- also be sure that the lifting components are suitable

for the application

- do not sit loads on the chain sling
- reduction of working load limits is necessary when making lifts at severe angles
- consult charts when using alloy chain at extreme temperatures
- working load limits must be reduced when using endless and basket slings
- extreme caution should be used when using hooks for lifting molten metal or chemicals
- chain slings shall be loaded properly to avoid damage to chain and load
- keep personnel away from loads being lifted

4. Maintenance and tests

- The chain sling must be visually inspected before use. If damage is found, you must consult a chain expert according to DGUV-R 100-500.
- The product must be removed from service if the following damage is found:
 - unreadable tags
 - breaks or deformation
 - cuts, notches, grooves or cracks
 - strong corrosion
 - heating over the admissible temperature allowed
 - elongation of chain must not exceed 5% of manufacturer's published size
 - elongation of the overall chain length shall not exceed 5%
 - to determine wear rejection on the diameter of a link, you must measure the horizontal and the vertical and reject if reduction is more than 10%.
 - reject hooks if throat opening is opened greater than 10% of new hook or the safety latch does not seat properly
 - wear of hook eye or hook body exceed 5%
 - missing or damaged safety latch of the hook or shortening component
 - incorrect screw replacement on lifting eyes
 - incorrect or damaged bolts or turn off locking
- Do not repair chain slings yourself unless fully trained. Please contact the manufacturer or a repair expert. Use only original spare parts from THIELE.

5. Regular inspections

Regular inspection shall include measurement and visual inspection and should be carried out once each year at minimum. Each third year inspection must include crack detection (magna flux). On a new chain, you must set up a chain card index that shall contain a description of the chain as well as the identity of the certificate. The inspection schedule must be fixed. The condition of chain slings or lashing chains and their components shall be noted at each inspection. If damage is repaired, all repairs and details must be noted on the chain card.

All operation manuals are available in the THIELE download-center on our website www.THIELE.de

