

# CD1-k User Guide

gb



## CANopen Amplifier

**WARNING**

This is a general manual describing a series of servo amplifiers having output capability suitable for driving AC brushless sinusoidal servo motors. This manual may be used in conjunction with appropriate and referenced drawings pertaining to the various specific models.

Please see [CD1-k Installation Guide](#) for the hardware installation of the amplifier (dimensions, wiring, ...).

For the CANopen communication, see manual [CD1-k – CANopen Communication Profile](#).

**Instructions for storage, use after storage, commissioning as well as all technical details require the MANDATORY reading of the manual before getting the amplifiers operational.**

**Maintenance procedures should be attempted only by highly skilled technicians having good knowledge of electronics and servo systems with variable speed (EN 60204-1 standard) and using proper test equipment.**

The compliance with the standards and the "CE" approval is only valid if the items are installed according to the recommendations of the amplifier manuals. Connections are the user's responsibility if recommendations and drawings requirements are not met.



Any contact with electrical parts, even after power down, may involve severe physical damage. Wait for at least 5 minutes after power down before handling the amplifiers (a residual voltage of several hundreds of volts may remain during a few minutes).

**ESD INFORMATION (ElectroStatic Discharge)**

INFRANOR amplifiers are conceived to be best protected against electrostatic discharges. However, some components are particularly sensitive and may be damaged if the amplifiers are not properly stored and handled.

**STORAGE**

- The amplifiers must be stored in their original package.
- When taken out of their package, they must be stored positioned on one of their flat metal surfaces and on a dissipating or electrostatically neutral support.
- Avoid any contact between the amplifier connectors and material with electrostatic potential (plastic film, polyester, carpet...).

**HANDLING**

- If no protection equipment is available (dissipating shoes or bracelets), the amplifiers must be handled via their metal housing.
- Never get in contact with the connectors.

**ELIMINATION**

In order to comply with the 2002/96/EC directive of the European Parliament and of the Council of 27 January 2003 on waste electrical and electronic equipment (WEEE), all INFRANOR devices have got a sticker symbolizing a crossed-out wheeled dustbin as shown in Appendix IV of the 2002/96/EC Directive.

This symbol indicates that INFRANOR devices must be eliminated by selective disposal and not with standard waste.

INFRANOR does not assume any responsibility for physical or material damage due to improper handling or wrong descriptions of the ordered items.

Any intervention on the items, which is not specified in the manual, will immediately cancel the warranty.

Infranor reserves the right to change any information contained in this manual without notice.

# Content

	PAGE
<b>CONTENT</b> .....	<b>3</b>
<b>CHAPTER 1 - GENERAL DESCRIPTION</b> .....	<b>4</b>
1 - INTRODUCTION .....	4
2 - ARCHITECTURE OF THE AMPLIFIER .....	4
<b>CHAPTER 2 - COMMISSIONING</b> .....	<b>6</b>
1 - INSTALLATION OF THE PARAMETER SETTING SOFTWARE .....	6
2 - CHECKING THE AMPLIFIER HARDWARE CONFIGURATION .....	6
3 - POWERING OF THE AMPLIFIER .....	6
4 - STARTING AND ADJUSTING THE AMPLIFIER .....	7
4.1 - AMPLIFIER ADJUSTMENT TO THE MOTOR SPECIFICATIONS .....	7
4.2 - $I^2t$ PROTECTION .....	10
4.3 - SERVO LOOP ADJUSTMENT .....	11
4.4 - ROTATION / COUNTING DIRECTION .....	12
5 - PARAMETER SAVING .....	12
6 - MOTOR PHASING (PHASING) AT POWER ON .....	12
7 - INCREMENTAL ENCODER OUTPUTS .....	13
8 - COGGING TORQUE COMPENSATION .....	13
<b>CHAPTER 3 - FUNCTIONAL FEATURES</b> .....	<b>15</b>
1 - LOGIC INPUTS .....	15
1.1 - "INHIBIT" INPUT .....	15
1.2 - "LIMIT SWITCH" INPUTS .....	15
1.3 - "LOW SPEED" INPUT .....	15
1.4 - "INDEX" INPUT .....	15
2 - BRAKE CONTROL .....	15
3 - ADDRESSING SWITCH / SPEED SELECTION .....	16
<b>CHAPTER 4 - CANOPEN COMMUNICATION</b> .....	<b>17</b>
<b>CHAPTER 5 - TROUBLESHOOTING &amp; MAINTENANCE</b> .....	<b>18</b>
1 - ERRORS .....	18
1.1 - "SYSTEM" ERROR .....	18
1.2 - NON STORED ERRORS .....	18
1.3 - STORED ERRORS .....	18
2 - ERROR RESET .....	23
3 - OPERATION PROBLEMS .....	23
3.1 - MOTOR DOES NOT MOVE .....	23
3.2 - MOTOR ENABLED BUT LITTLE TORQUE .....	23
3.3 - SHAFT LOCKED – ERRATIC OSCILLATIONS - rotation AT MAXIMUM SPEED .....	23
3.4 - DISCONTINUOUS MOTOR ROTATIONS WITH ZERO TORQUE POSITIONS .....	23
3.5 - LOUD CRACKLING NOISE IN THE MOTOR AT STANDSTILL .....	23
4 - SERVICE AND MAINTENANCE .....	23

# Chapter 1 - General description

## 1 - INTRODUCTION

**CD1-k** all-digital amplifiers with sinusoidal PWM control are servo amplifiers that provide the control of brushless AC motors with position sensor.

The **CD1-k** amplifier is a stand-alone single-axis block including power supply unit and mains filters. It is available in both 230 VAC and 400/480 VAC mains operated voltages.

**CD1-k** amplifiers are working via a bus with "**CANopen**" communication protocol.

The amplifier parameter setting can be made either by means of:

- the **CANopen** bus or
- the specific parameter setting software **Visual Drive Setup**, via the serial port RS-232.

## 2 - ARCHITECTURE OF THE AMPLIFIER

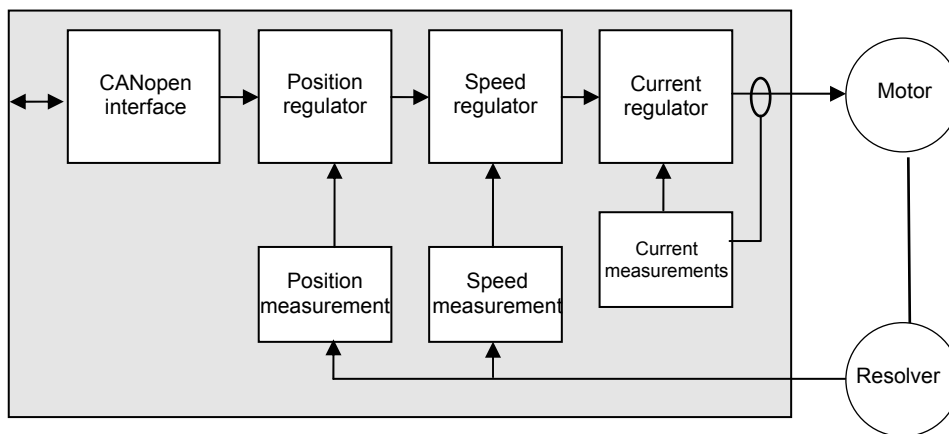

<b>Electric motor</b>	Electric device that transforms electrical energy into a mechanical movement. This transformation is often made by means of current commutation. Generally, the movement is a rotation but there are also linear motors.
<b>Brushless or synchronous motor</b>	Electric brushless motor. The current commutation is electronically made and requires a position sensor (resolver, encoder, Hall sensor...).
<b>Resolver</b>	Absolute position sensor over one revolution. The resolver is often used together with brushless motors because of its robustness.
<b>Encoder</b>	Incremental or absolute position sensor. The encoder is used together with brushless motors for its accuracy.
<b>Amplifier</b>	Electric device for the control of electric motors. It also includes a current regulator, a speed regulator and, often, a position regulator.
<b>Current loop</b> Current regulator	Used for the motor current control. The motor torque is generally proportional to the current amplitude.
<b>Speed loop</b> Speed regulator	Allows the motor speed control.
<b>Position loop</b> Position regulator	Allows the motor position control.
<b>Fieldbus</b>	Digital link that allows real time data exchange between various electric devices. The characteristic of fieldbuses is their high protection and error correction level as well as a predictable communication time.
<b>CANopen</b>	Communication protocol on CANbus – Standards: CiA DS301 / CiA DSP402.
<b>Enabled/disabled</b> ( <i>Servo On/Off</i> )	When a motor is enabled, it is controlled by the amplifier and the servo loops are operating. When it is disabled, its rotation is free and there is no current in the motor.

## Chapter 2 - Commissioning

### **CAUTION !**

Do not make the amplifier parameter setting by means of both Visual Amplifier Setup software and CANopen bus at the same time.

### **1 - INSTALLATION OF THE PARAMETER SETTING SOFTWARE**

The **Visual Drive Setup** software is PC compliant under Windows®<sup>1</sup> and allows an easy parameter setting of the CD1-k amplifier.

Please see our website [www.infranor.fr](http://www.infranor.fr) for downloading the "Visual Amplifier Setup" software.

### **2 - CHECKING THE AMPLIFIER HARDWARE CONFIGURATION**

The standard amplifier configuration is adjusted to MAVILOR motors (resolver sensor with transformation ratio = 0.5);

For the adjustment to other motor types, please see "[CD1-k - Installation Guide](#)".

### **3 - POWERING OF THE AMPLIFIER**

Please see manual "[CD1-k - Installation Guide](#)" before switching on the amplifier for the first time.

For switching on the amplifier, please proceed as follows:

- Switch on the +24V auxiliary supply:

The green front panel LED "**OK**" must blink quickly ("Undervolt." error displayed).  
The AOK relay contact (pins 9 and 10 of X2) is closed. It is then possible to control the power ON relay.

- Switch on the power supply:  
The green LED "**OK**" must be continuously lit: the amplifier is ready to be enabled.

### **CAUTION !**

The 24 V auxiliary supply must **always** be switched on **before** the power supply.

It is mandatory to wait for at least 30 seconds between switching off and on again the amplifier.

<sup>1</sup> Windows® is a registered trade mark of MICROSOFT® CORPORATION

## 4 - STARTING AND ADJUSTING THE AMPLIFIER

This chapter describes the commissioning procedure of the amplifier by means of the " **Visual Amplifier Setup**" software.

- Connect the serial link RS232 between PC and amplifier.
- Switch on the amplifier and start the **Visual Drive Setup** software on the PC, under WINDOWS®.

If the message **No serial communication found** is displayed on the screen, click on OK and check the following points:

- The amplifier must be on,
- The correct RS232 connection between amplifier and PC,
- The correct software configuration (**Com.port**, ...).

For a parameter setting of the amplifier via the **Visual Drive Setup** software:

- Switch the amplifier to **Local** mode, that means switch address = 0 (see [Chapter 3, section 3](#)),  
**or**
- Disable the **CANopen** communication by means of **Visual Drive Setup**.

### 4.1 - AMPLIFIER ADJUSTMENT TO THE MOTOR SPECIFICATIONS

#### 4.1.1 - CONFIGURATION OF THE SENSOR TYPE

The configuration of the sensor type is software selectable and saved in the amplifier EEPROM.

The amplifier is configured as standard for a resolver sensor. For motors equipped with a position encoder, please proceed as follows:

- ◆ Select the appropriate encoder type in the **Feedback configuration** menu.
- ◆ Then select **Encoder feedback** and confirm this selection.

If the motor is equipped with Hall effect sensors, check that the INHIBIT input is enabled and the amplifier is on, before moving manually the motor over one revolution or one pole pitch on linear motors. If the **HES** error is displayed, switch off the amplifier and check the following points before switching it on again:

- ◆ The Hall effect sensors (HES) must be correctly connected on the amplifier X3 connector (if 60° Hall sensor types are used, check the various wiring combination of the HES signals for finding the right wiring order).
- ◆ Check for the correct supply voltage of the Hall sensors.
- ◆ Check for the correct value of the **Motor encoder resolution** parameter.

If the motor Hall sensors do not work correctly, select the appropriate incremental encoder type (**Incremental Encoder**) (without HES) in the **Feedback configuration** menu and start the amplifier commissioning with this configuration.

If the motor used is equipped with an absolute Sin/Cos encoder over one revolution (Heidenhain ERN 1085 or compliant), check that the INHIBIT input is enabled and the amplifier on. Then move manually the motor over one revolution. If the **HES** error is displayed, switch off the amplifier and check the following points before switching it on again:

- ◆ The commutation channels of the Sin/Cos encoder must be correctly wired on the amplifier X3 connector.
- ◆ Check for the correct supply voltage of the Sin/Cos encoder.
- ◆ Check for the correct value of the **Motor encoder resolution** parameter.

Perform the **Save parameters to EEPROM** procedure before switching off the amplifier in order to save the sensor configuration.

#### 4.1.2 - SELECTION OF THE MOTOR TYPE

##### THE MOTOR USED IN THE APPLICATION IS CONTAINED IN THE MOTOR LIST OF THE PARAMETER SETTING SOFTWARE

Select, in the motor list, the motor used in the application.

The motor selection will start the automatic calculation of the current loop parameters.

Check that the values of the parameters **Max. current** and **Rated current** are compliant with motor and amplifier. If necessary, modify them according to the motor and amplifier specifications.

The parameter **Max current** defines the maximum output current value of the amplifier. It may vary between 20 % and 100 % of the amplifier current rating.

The parameter **Rated current** defines the limitation threshold of the amplifier output RMS current ( $I^2t$ ). It can vary between 20 % and 50 % of the amplifier current rating.

If the **Incremental encoder without HES** sensor configuration is selected, start a motor phasing (**Phasing**) procedure.

The motor phasing can be launched either in the control window of the **VISUAL DRIVE SETUP** software or via the CANopen bus.

##### THE MOTOR USED IN THE APPLICATION IS NOT CONTAINED IN THE MOTOR LIST OF THE PARAMETER SETTING SOFTWARE

Select the **New Motor** function and follow the instructions.

#### 4.1.3 - ENCODER COUNTING PROTECTION

When servo motors are equipped with an encoder, any error in the encoder pulse counting generates an error in the position measurement of the rotor and may involve uncontrolled motor movements that can be dangerous for both operator and machine. The encoder counting protection of the CD1-k amplifier range allows the detection of pulse counting errors and immediately disables the amplifier for reasons of security.

The encoder counting protection checks that the number of encoder pulses between two successive Z marker pulses (or R reference signals) is equal to the value of the **Motor encoder resolution** parameter multiplied by the value of the **Zero mark pitch** parameter. The encoder counting protection also checks that the encoder pulse frequency is lower than 1,5 times the maximum encoder frequency. The maximum encoder frequency is calculated in the amplifier according to the value of the **Motor encoder resolution** and **Maximum speed** parameters.

The value of the **Motor encoder resolution** parameter defines the number of encoder pulses (or encoder signal periods) per motor revolution (for a rotary motor) or per motor pole pairs (for a linear motor).

The value of the **Zero mark pitch** parameter defines the number of motor revolutions (for a rotary motor) or of motor pole pairs (for a linear motor) between two successive Z marker pulses (or R reference signals).

With a rotary motor, the **Zero mark pitch** parameter is generally equal to 1 because the encoder has got one Z marker pulse (or one R reference signal) per motor revolution.

On a linear motor with only one marker pulse over the whole motor travel, the **Zero mark pitch** parameter must be defined at 15. In this case, the encoder counting protection checks that the measured encoder position has still got the same value when the marker pulse is activated (no drift in the position measurement).

**Note:** In the **Incremental encoder without HES** configuration, the motor phasing procedure (**Phasing**) must be renewed after the release of a **Counting** error because the current rotor position reference for the motor commutation is not correct.

#### 4.1.4 - PARAMETER ADJUSTMENT FOR A LINEAR MOTOR

The **Motor encoder resolution** parameter is calculated as follows:

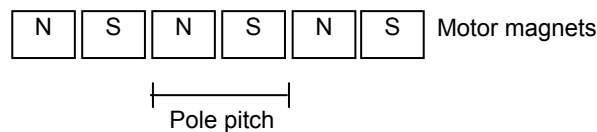

$$\text{Motor encoder resolution} = 1000 \times \frac{\text{Motor pole pitch (mm)}}{\text{Encoder signal pitch}}$$



**1 encoder signal pitch = 4 counting increments**

The value of the motor **Maximum speed** parameter in rpm is calculated as follows:

$$\text{Max. speed (rpm)} = 60 \times \frac{1000}{\text{Motor pole pitch (mm)}} \times \text{max. motor speed (m/s)}$$

The linear speed value in m/s is calculated as follows:

$$\text{Linear speed (m/s)} = \frac{\text{Motor speed (rpm)}}{60} \times \frac{\text{Motor pole pitch (mm)}}{1000}$$

#### 4.1.5 - MAXIMUM APPLICATION SPEED

The parameter **Max. speed** defines the maximum speed at which the amplifier can control the motor. This parameter can be:

- lower than or equal to the maximum motor speed,
- slightly higher than the maximum motor speed in the application. This margin allows a speed overshoot that avoids the position loop saturation (position following). This margin can be as small as possible when using a high bandwidth or at low acceleration.

#### 4.1.6 - CONFIGURATION OF THE THERMAL SENSOR

##### 4.1.6.1 - Selection of the sensor type

The motor can be equipped either with a CTN sensor (ohmic resistance = decreasing temperature function) or with a CTP sensor (ohmic resistance = increasing temperature function).

Check that the selected thermal sensor type actually corresponds to the sensor type mounted on the application motor.

##### 4.1.6.2 - Triggering threshold adjustment

Enter the sensor ohmic value (kOhm) corresponding to the required temperature value for the release of the **Motor overtemperature** protection, according to the manufacturer's specifications.

##### 4.1.6.3 - Warning threshold adjustment

Enter the sensor ohmic value (kOhm) corresponding to a warning temperature value. When the warning temperature is reached, an information is sent via the **CANopen** bus.

##### Note

When using a CTN sensor, the warning ohmic value will be higher than or equal to the triggering ohmic value. When using a CTP sensor, the warning ohmic value will be lower than or equal to the triggering ohmic value.

## 4.2 - I<sup>2</sup>T PROTECTION

2 selection modes are available: **Fusing** or **Limiting**.  
It is advisable to use the **Fusing** mode during commissioning phases.

In **Fusing** mode, the amplifier is disabled when the current limitation threshold is reached.

In **Limiting** mode, the motor current is only limited at the value defined by the **Rated current** parameter when the limitation threshold is reached.

### 4.2.1 - OPERATION OF THE CURRENT LIMITATION IN "FUSING" MODE

When the amplifier output RMS current (I<sup>2</sup>t) reaches 85 % of the rated current, the **OK** LED is blinking on the amplifier front panel. If the RMS current (I<sup>2</sup>t) has not dropped below 85 % of the rated current within 1 second, the I<sup>2</sup>t error is released and the amplifier disabled (otherwise, the blinking is inhibited).

When the amplifier output RMS current (I<sup>2</sup>t) reaches the rated current value, the I<sup>2</sup>t limits the amplifier output current at this value.

Diagram of the amplifier output current limitation in an extreme case (motor overload or shaft locked):

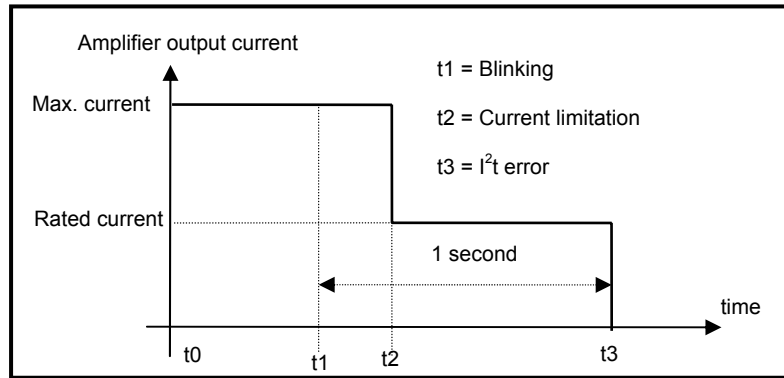

The maximum current duration before release of the blinking display is depending on the value of the parameters **Rated current** and **Max. current**. This value is calculated as follows:

$$T_{\text{dyn}} \text{ (second)} = t_1 - t_0 = 3,3 \times \left[ \frac{\text{rated current (A)}}{\text{max. current (A)}} \right]^2$$

The maximum current duration before limitation at the rated current is also depending on the value of the **Rated current** and **Maximum current** parameters. This value is calculated as follows:

$$T_{\text{max}} \text{ (second)} = t_2 - t_0 = 4 \times \left[ \frac{\text{rated current (A)}}{\text{max. current (A)}} \right]^2$$

#### NOTE 1

When the "Max. current / Rated current" ratio is close to 1, the T<sub>dyn</sub> and T<sub>max</sub> values given by the formula above are quite below the real values. But this formula remains very precise as long as the "Max. current / Rated current" ratio is higher than 3/2.

#### NOTE 2

The amplifier I<sup>2</sup>t signal can be displayed on the digital oscilloscope by selecting the I<sup>2</sup>t signal in the **Channel** menu. The threshold values of the I<sup>2</sup>t signal, for the protection mode described above, are calculated as follows:

$$\text{Triggering threshold of the Idyn signal (\%)} = \left[ \frac{\text{Rated current (\%)}}{70} \right]^2$$

$$\text{Current limitation threshold (\%)} = \left[ \frac{\text{Rated current (\%)}}{50} \right]^2$$

$$\text{Rated current (\%)} = 100 \times \frac{\text{Rated current (A)}}{\text{amplifier current rating (A)}}$$

The corresponding RMS current value of the amplifier can be calculated as follows:

$$\text{Amplifier RMS current (A)} = \left[ \frac{\text{I}^2\text{t signal value (\%)} \times 50 \right]^{1/2} \times \text{amplifier current rating (A)} / 100$$

#### 4.2.2 - CURRENT LIMITATION IN "LIMITING" MODE

When the amplifier output RMS current ( $I^2t$ ) reaches 85 % of the rated current, the **OK** LED on the amplifier front panel is blinking. When the RMS current ( $I^2t$ ) drops below 85 % of the rated current, the blinking is inhibited.

When the amplifier output RMS current ( $I^2t$ ) reaches the rated current value, the  $I^2t$  protection limits the amplifier output current at this value.

Diagram of the amplifier output current limitation in an extreme case (motor overload or shaft locked):

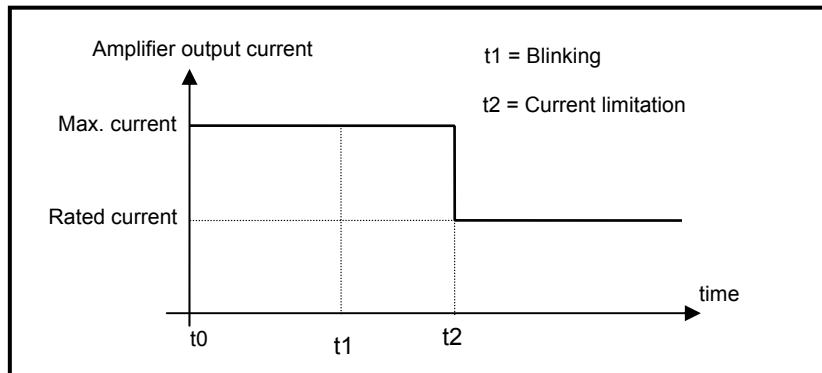

The maximum current duration before release of the blinking display ( $t_1 - t_0$ ) and before limitation at the rated current ( $t_2 - t_0$ ) is calculated the same way as in the "Fusing" mode.

### 4.3 - SERVO LOOP ADJUSTMENT

#### 4.3.1 - REGULATOR PARAMETERS

The **Autotuning** procedure identifies the motor and load specifications and calculates the speed/position loop parameters.

In **P** and **PI** speed mode, only the speed loop gains are calculated.

In **PI<sup>2</sup>** speed mode, the proportional gain of the position loop is also calculated. But the **Feedforward** gains of the position regulator are all initialized at 0.

In **Position** mode, all gains of both speed **and** position regulators are calculated.

**Note:** The position loop stability can be tested in **PI<sup>2</sup>** speed mode because the **Feedback** gains are identical to the **Position** mode.

The operator can select a bandwidth (**Low**, **Medium** or **High**) as well as the filter type (**standard**, **antiresonance** or **max. stiffness**).

The **Autotuning** procedure can be executed with the motor disabled or enabled (i.e. vertical load).

Before executing the **Autotuning** procedure, check that the motor shaft is free and that its rotation over one revolution is not dangerous for operator and machine. Check that the brake is released (the **Autotuning** command does not control the brake).

For a complete adjustment, the **Autotuning** procedure must **always** be executed in **Position** mode (at power on, the amplifier is automatically in **Position** mode).

But the amplifier position loop stability can also be tested in **Speed** mode. In this case, after the execution of the **Autotuning** procedure in **PI<sup>2</sup>** mode:

- check that the motor is correctly running in both directions,
- check the **response at a small displacement without Idc saturation** (oscilloscope function).

In case of loud noise in the motor at standstill or when running, check the rigidity of the mechanical transmission between motor and load (backlashes and elasticities in motor and couplings).

If required, start a new **Autotuning** procedure by selecting a lower bandwidth.

If the instability remains, start a new **Autotuning** procedure by activating the **Antiresonance** filter. If necessary, adjust more accurately the loop response stability by adjusting the stability gain.

#### 4.3.2 - LOOP ADJUSTMENT WITH A VERTICAL LOAD

In the case of an axis with vertical load, proceed as follows:

Select the **Limiting** current limitation mode.

Initialize the speed loop gains corresponding to the unloaded motor (execute therefore the **Autotuning** procedure with the motor uncoupled from its mechanical load).

Couple the motor with its load. If possible, make a control in speed mode; otherwise, close the position loop with a stable gain.

Move the axis by means of the speed input command until a stall position where one motor revolution is not dangerous for operator and machine (far enough from the mechanical stops).

Execute then the **Autotuning** procedure with the motor at standstill. If the axis is moving, this means that the **Autotuning** has not been accepted by the amplifier.

#### 4.4 - ROTATION / COUNTING DIRECTION

The counting direction can be reversed by selecting the **Reverse movement** in the **Visual Drive Setup** parameter setting software.

#### 5 - PARAMETER SAVING

When all adjustments have been made, the parameters may have to be **stored** in a non volatile EEPROM (the amplifier must be disabled).

#### 6 - MOTOR PHASING (PHASING) AT POWER ON

In the **Incremental encoder without HES** configuration, the motor phasing procedure (**Phasing**) must be performed at each power on of the amplifier according to the diagram below:

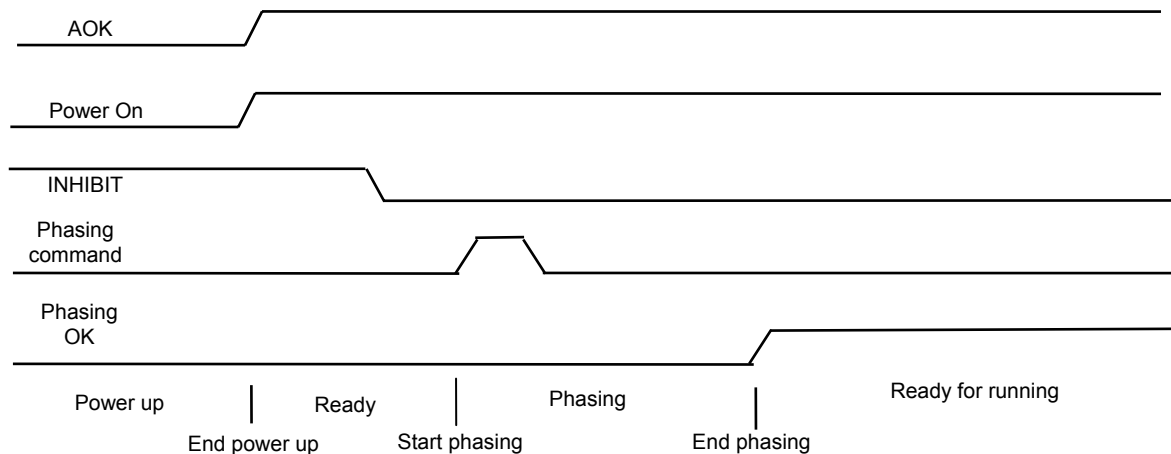

**On an unbalanced axis (constant torque due to gravity effects on a vertical axis), the motor phasing procedure is not possible. The motor must be equipped with an incremental encoder + HES or with an absolute Sin/Cos encoder.**

Note : In the **Incremental encoder without HES** configuration, the motor phasing procedure (**Phasing**) must be renewed after the release of a **Feedback** or **Counting** error. The motor phasing procedure must also be renewed after modification of the motor or encoder parameter value.

## 7 - INCREMENTAL ENCODER OUTPUTS

The incremental encoder outputs are two pulse channels A and B in quadrature and one Z marker pulse per revolution.

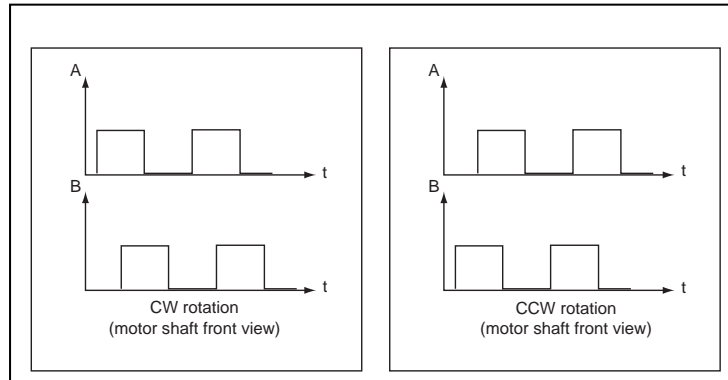

The **Output encoder resolution** is selected according to the table below:

Maximum motor speed (rpm)	up to 1600	up to 3200	up to 6400	up to 12800	up to 25000
Encoder output resolution (ppr)	512 to 16384	512 to 8192	512 to 4096	512 to 2048	512 to 1024

The resolution value defined in the **Output encoder resolution** parameter can be divided by 2, 4 or 8 by selecting the **Resolution division ratio** parameter.

The **Output encoder deadband** parameter introduces a deadband at standstill around the current resolver position in order to avoid oscillations of +/- 1 encoder edge on channels A and B. The value of 4095 corresponds to 1/16 revolution of the motor shaft.

The **Zero pulse origin shift** parameter allows the shifting of the marker pulse position on channel Z with regard to the resolver zero position. The value 32767 corresponds to one revolution of the motor shaft. The marker pulse width is equal to 1/4 of the A and B channels period.

## 8 - COGGING TORQUE COMPENSATION

The cogging torque in brushless permanent magnet rotating motors or the cogging force in brushless permanent magnet linear motors results from the interaction between the rotor magnets and the stator slots. This disturbance is due to the difference of reluctance between the copper of the windings and the iron of the stator teeth. For a given motor, the cogging can be easily evaluated by simply moving the motor manually when the amplifier is disabled. The Cogging compensation option available in the CD1 amplifier range allows to cancel the motor cogging effects for specific applications where torque accuracy or force accuracy higher than 1 % is required. CD1 amplifiers must be factory set for getting the cogging compensation option (reference CD1k-U/I-CT). Check for the presence of the cogging compensation option (**CT-CD1**) in the **VDSetup** Hardware option menu. In this case, the **Cogging torque compensation** menu can be selected in the **Servo loop** module.



**For a brushless motor equipped with an incremental encoder, the Cogging torque compensation is only available if the encoder is providing one marker pulse per motor revolution.**

The cogging torque acquisition procedure is started by means of the **Start** button. The motor must be uncoupled from its load and the shaft must not be disturbed during the procedure. Before starting the acquisition, switch the drive on manual mode and then disable it (Drive control = Off). Then, start the **Auto-tuning** procedure with following selections: Regulator = PI<sup>2</sup>, Filter = Max. stiffness and Bandwidth = High. At the end of the cogging torque acquisition procedure, the amplifier parameter file (\*.PAR) can be uploaded again in order to recover the initial adjustments.

The **Enable cogging torque compensation** function allows the commissioning of the motor cogging torque compensation. This function is saved in the amplifier EEPROM.

The **Save cogging torque data into a file** function allows to store in a PC the cogging torque value corresponding to a motor after the acquisition procedure (\*.COG file).

The **Write cogging torque data into the drive** function allows to upload in the amplifier the cogging torque value corresponding to a motor, if this value has previously been stored in the PC (\*.COG file).



**For a brushless motor equipped with an incremental encoder, the Cogging torque compensation is only available if the encoder is providing one marker pulse per motor revolution.**

Note 1:

The motor cogging torque value is checked at the amplifier power up. If it contains some errors (storage problems in the amplifier memory), the EEPROM error is displayed and the **Enable cogging torque compensation** function is disabled.

Note 2:

When exchanging an amplifier on an axis, the file of the adjustment parameters (\*.PAR) as well as the cogging torque file (\*.COG) corresponding to the motor must be uploaded once again in the amplifier.

Note 3:

When exchanging the motor or when disassembling the resolver sensor, the acquisition procedure must be renewed.

## Chapter 3 - Functional features

### 1 - LOGIC INPUTS

#### 1.1 - "INHIBIT" INPUT

Activating the **Inhibit** input during the operation makes the axis decelerate. At the end of the deceleration, the motor is automatically disabled.

The motor is enabled via the **CANopen** bus or via the **Visual Drive Setup** software, as the **Inhibit** input is disabled.

##### Notes:

- The amplifier inhibiting function is activated if the "**Inhibit**" input is **disconnected** from the +24V potential.
- The **Deceleration** parameter can be parameter set via the **CANopen** bus.

#### 1.2 - "LIMIT SWITCH" INPUTS

The "Limit switch" inputs are inputs for a detection sensor that allows to stop the motor with maximum deceleration. The purpose of both limit switches, when they are mounted at the right place on the axis stroke, is to protect the mechanics in case of uncontrolled movements.

The limit switches are only defined according to the motor hardware rotation. They are independent from the "rotation/counting direction" selection.

For checking the wiring of the limit switch inputs:

- move the motor in one direction,
- activate the limit switch placed in the rotation direction (artificially, if necessary),
- check then the motor stopping; if the motor goes on moving, reverse the wiring of the limit switch inputs.

##### Notes:

- When activating a limit switch input, the motor is stopped with maximum deceleration.
- The limit switch inputs are activated if **disconnected** from the +24V potential.

#### 1.3 - "LOW SPEED" INPUT

When this input is activated, the amplifier switches to protected mode if the motor speed is exceeding the critical "Low speed" threshold.

##### Note:

- The **Low speed** parameter cannot be higher than 33 % of the **Max. speed** parameter.
- The **Low speed** input is activated if **disconnected** from the +24V potential.
- The **Low speed** threshold can be parameter set via the **CANopen** bus.

#### 1.4 - "INDEX" INPUT

In **Homing** mode, the **Index** input is used for a homing on the axis.

### 2 - BRAKE CONTROL

The **CD1-k** amplifier has got a control for the operation of a "powerless" brake.

The brake control is enabled (relay open) or disabled (relay closed) according to the amplifier status (**enabled** or **disabled**).

### 3 - ADDRESSING SWITCH / SPEED SELECTION

Each amplifier of the network must be configured with one single address.

A DIP8 switch accessible to the operator allows the configuration of the amplifier address as well as of the of the **CANopen** bus communication speed.

- Addressing (6 selection bits)

Status of the cursors						Address
6	5	4	3	2	1	
OFF	OFF	OFF	OFF	OFF	OFF	0
OFF	OFF	OFF	OFF	OFF	ON	1
OFF	OFF	OFF	OFF	ON	ON	3
...	...	...	...	...	...	...
ON	ON	ON	ON	ON	ON	63

- Communication speed (2 selection bits)

Status of the cursors		Speed
8	7	
OFF	OFF	1Mbits
OFF	ON	500Kbits
ON	OFF	250Kbits
ON	ON	125Kbits

Note:

- Address **00** must only be used in **Local** mode.
- An address  $\neq$  **00** is used in **Remote** mode (use of the **CANopen** bus).

## **Chapter 4 - CANopen communication**

For the commissioning of the **CANopen** communication protocols, please see manual "[CD1k – CANopen Communication Profile](#)".

## Chapter 5 - Troubleshooting & Maintenance

### 1 - ERRORS

#### 1.1 - "SYSTEM" ERROR

If the red "SYS" LED is lit at power on, the logic board is defective.

- Check that the **BUS** and **OK** leds are synchronously blinking. In this case, load the amplifier firmware via the serial link by means of the **CD1updater software**.
- Check for no conducting dust that may involve short-circuits on the amplifier logic board.

#### 1.2 - NON STORED ERRORS

##### 1.2.1 - BUS ERROR

This fault is displayed by the **BUS** led.

This error is only displayed when there is a synchronization loss by the **SYNC** message.

The error is cancelled as soon as the communication is restored.

##### 1.2.2 - "UNDERVOLT." ERROR

This fault is displayed by a quick blinking of the **OK** led.

When switching on the auxiliary 24 VDC supply, the CD1-k amplifier always displays the UNDERVOLT. fault. The UNDERVOLT. Led will go out when switching on the power voltage, after a few seconds time delay that corresponds to the power capacitors soft start. If the fault display remains after switching on the power supply, check that the power supply is actually on.

#### 1.3 - STORED ERRORS

If an error occurs on the amplifier, it can generate the detection of several other errors which are only a consequence of the initial one. In order to make diagnostic and maintenance easier, the errors are displayed and processed with the precedence described below. For safety reasons, the power must be turned off for the cancelling of some errors that requires the handling of the amplifier; in this case, the amplifier is automatically reset when power is turned on again. If power is not turned off, do not forget to make a RESET immediately after the error is cancelled.

##### 1.3.1 - "BUSY" ERROR

- If the **BUSY** error is displayed after power on, the AUTOTEST procedure has failed and the amplifier is not ready for operation. **Check that the power voltage is not on before the 24 V auxiliary supply.**
- If the **BUSY** fault is continuously displayed after the motor **PHASING** procedure at power up (**Incremental encoder without HES** configuration), the procedure has failed because of an external cause and the calculated phase value is wrong.
  - Check that the **Motor encoder resolution** parameter value is correct.
  - Check that the **Motor parameters (Pole pairs and Phase order)** values are correct.
  - Check that the **INHIBIT** input is disabled.
  - Check that the limit switches inputs are not activated.
  - Check that the motor is not locked and the shaft movement is free during the procedure.
- If the **BUSY** error is displayed after execution of the **Autophasing**, this procedure has failed because of an external cause and the calculated parameters are wrong.
  - Check at first the status of the amplifier logic inputs. Check that the motor is unloaded and the shaft movement is free during the procedure.

- If the **BUSY** error is displayed after execution of the **Autotuning**, this procedure has failed because of an external cause and the calculated parameters are wrong.  
Check at first the status of the **INHIBIT** input and of the limit switches. Then check that the motor shaft is free during the execution of the procedure.
- If the **BUSY** fault is continuously displayed after the execution of the **COGGING TORQUE ACQUISITION** procedure, the procedure has failed because of an external cause and the cogging torque acquisition is not valid.  
Check that the **INHIBIT** input is disabled.  
Check that the limit switch inputs are not activated.  
Check that the encoder is providing one marker pulse per motor revolution.  
Check that the motor is unloaded and the shaft movement is free during the procedure.  
Check that the motor current value corresponding to the cogging torque effect is lower than 5 % of the amplifier current rating.
- This error may also occur during a homing procedure which time-out is too low.

### 1.3.2 - "EEPROM" ERROR

- Check for the presence of the EEPROM and check its correct orientation.
- If the error remains, the EEPROM may not be correctly initialized (**CHECKSUM**) or is not compatible with the amplifier software.
- To cancel this error, make a new parameter setting of the amplifier and save the new parameters.

### 1.3.3 - "°C MOTOR" ERROR

If the error occurs when commissioning the amplifier:

- Check the **CTN/CTP** parameter setting, the **Triggering threshold** and the **Warning threshold**.
- Check the wiring of the thermal sensor on the amplifier.

If the error occurs during the operation:

- Check that the triggering threshold is compliant with the manufacturer's specifications of the sensor.
- Check the motor temperature and look for the reason of this overheating (mechanical shaft overload, duty cycle too high, ...).

### 1.3.4 - "POWER STAGE" ERROR

The **POWER STAGE** fault groups all faults issued from the power board:

- Power supply overvoltage.
- Phase/ground short-circuit.
- Phase/phase short-circuit.
- Fan.
- Power stage short-circuit.
- Power stage overtemperature (on CD1-k-400/I only).
- PWM control error.
- Power stage supply.
- Braking system error: transistor short-circuit or cycle too high.

The **VISUAL DRIVE SETUP** software allows to identify the "Power stage" fault.

If the fault occurs when starting the amplifier:

- Check the AC voltage on the L1 - L2 - L3 inputs of the X9 connector.

<b>CD1-k-230/I amplifier</b>	<b>:</b>	<b>196 VAC &lt; VAC &lt; 253 VAC</b>
<b>CD1-k-400/I amplifier</b>	<b>:</b>	<b>340 VAC &lt; VAC &lt; 528 VAC</b>

If the fault occurs during the operation:

- Check the braking system during the motor deceleration phases.
- Check the sizing of the braking resistor with regard to the motor deceleration phases.
- Check that the current cycle corresponds to the current table ([see table of the current ratings](#)).
- Check for no short-circuit in the motor wiring and at the motor terminals.
- Check for no short-circuit between a motor phase and the ground.

**1.3.5 - "RESOLVER" ERROR**

- Check the resolver connection on the amplifier X1 connector according to the connector description.
- Check for the correct resolver type with regard to the amplifier specifications.
- Check the connections between the resolver and the amplifier.

**1.3.6 - "RDC" ERROR**

If the failure occurs when starting the amplifier:

- Check for the correct resolver type with regard to the amplifier specifications.

If the failure occurs during the operation:

- Check that the connections between the resolver and the amplifier are complying with the shield wiring recommendations.

**1.3.7 - "ENCODER" ERROR**

Check the encoder supply connection on the amplifier connector X3.  
 Check the encoder A channel and B channel connections on the amplifier connector X3.

**Note:** In the **Incremental encoder without HES** configuration, the motor **Phasing** procedure must be carried out again after an **Encoder** fault release.

**1.3.8 - "COUNTING" ERROR**

Check the marker pulse connection on the amplifier connector X3. If the motor encoder is not providing a marker pulse channel output, the amplifier marker pulse channel must be disabled in order to cancel the **Counting** fault. The amplifier marker pulse channel can be disabled by means of the parameter **Zero mark pitch** set at 0.



When the amplifier marker pulse channel has been disabled, the encoder counting protection is no more active. In this case, encoder pulse noise may involve uncontrolled motor movements that may be dangerous for operator and machine.

For the **TTL incremental encoder** configuration:

- Check for the correct encoder supply voltage value.
- Check for the correct encoder-amplifier-motor ground and shield connections with regard to the recommendations in [chapter 4 of the CD1-k Installation Guide](#).
- Check for the correct encoder A channel, B channel and Z marker signal waveforms.

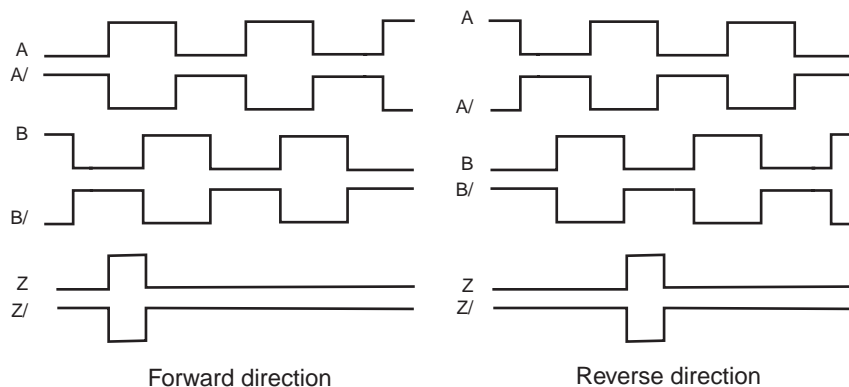





When the encoder counting protection has been disabled, the amplifier is only checking that the encoder pulses frequency is lower than 1.5 times the maximum encoder frequency. The maximum encoder frequency is calculated into the amplifier according to the **Motor encoder resolution** parameter value and the **Maximum speed** parameter value. In this case, encoder pulse noise at a frequency lower than 1.5 times the maximum encoder frequency may involve uncontrolled motor movements that may be dangerous for operator and machine.

**Note:** In the **Sin/Cos encoder without HES** configuration, the motor **Phasing** procedure must be executed again after a **Counting** fault release.

### 1.3.9 - "HES" ERROR

For the **Incremental encoder & HES** configuration:

- Check that the HES are correctly wired on the amplifier X3 connector (with 60° type HES you must check the various wiring combinations to find the right wiring order).
- Check for the correct HES supply voltage value.
- Check for the correct **Motor encoder resolution** parameter value.
- Check that the HES-amplifier-motor ground connections and shield answer the requirements of [chapter 4 of the CD1-k Installation Guide](#).

For the **Absolute single-turn Sin/Cos encoder** configuration:

- Check that the Sin/Cos encoder commutation channels are correctly wired on the amplifier X3 connector.
- Check for the correct Sin/Cos encoder supply voltage value.
- Check for the correct Sin/Cos encoder C channel and D channel signal amplitude value.
- Check that the **Motor encoder resolution** parameter value is correct.
- Check that the encoder-amplifier-motor ground connections and shield answer the requirements of [chapter 4 of the CD1-k Installation Guide](#).

### 1.3.10 - "POSITION FOLLOWING" ERROR

If the error occurs during the axis motion:

- Check the position loop adjustment.
- Check the coherence of the **Static threshold** parameter with regard to the motion cycle.

### 1.3.11 - "LOW SPEED" ERROR

- Check that the **Low speed** parameter is coherent with regard to the axis motion speed.
- Check the wiring of the "Low speed" input.

### 1.3.12 - "CURRENT OFFSET" ERROR

If the "Current offset" error occurs at power on, this means that the offset compensation procedure has failed and the amplifier is not ready for operation. This error cannot be cancelled.

### 1.3.13 - "INIT 400V" ERROR

If the "INIT 400V" error occurs on a CD1-k **400**/I amplifier, at power on:

- Check that the amplifier powering has been correctly made.  
This error cannot be cancelled.

### 1.3.14 - "I<sup>2</sup>T" ERROR

- Check the rated current value required from the amplifier with regard to the current table in pulse cycle.
- Check the amplifier rated current value defined in the **Rated current** parameter with regard to the current required for the operation cycle.

## 2 - ERROR RESET

A stored error can be cancelled as follows:

- by means of the parameter setting software **Visual Amplifier Setup**, via the serial link RS232,
- by means of the **RESET** function issued from the **CANopen bus**,
- by switching off the amplifier supply.

## 3 - OPERATION PROBLEMS

### 3.1 - MOTOR DOES NOT MOVE

- Check that the amplifier is on.
- Check for no error on the amplifier.
- Check the wiring of the logic command inputs.
- Check that the amplifier is enabled.

### 3.2 - MOTOR ENABLED BUT LITTLE TORQUE

- Check the **Max. current** and **Rated current** parameters.

### 3.3 - SHAFT LOCKED – ERRATIC OSCILLATIONS - ROTATION AT MAXIMUM SPEED

- Check the resolver or encoder wiring on the amplifier connector as well as the mechanical fastening of the position feedback sensor on the motor.
- Check for the correct motor selection in the **MOTOR LIST** module.
- Check the value of the **Motor parameters** in the **Advanced Functions** menu and renew the **AUTO-PHASING** command, with unloaded motor, if required.

### 3.4 - DISCONTINUOUS MOTOR ROTATIONS WITH ZERO TORQUE POSITIONS

- Check the wiring of the three phases between motor and amplifier.

### 3.5 - LOUD CRACKLING NOISE IN THE MOTOR AT STANDSTILL

- Check that the Motor - Amplifier - Host system ground connections comply with the wiring recommendations.
- Check the rigidity of the mechanical transmission chain between motor and load (backlashes and elasticity in the gears and couplings).
- Start a new **Autotuning** procedure by selecting a lower bandwidth than the initial one.

## 4 - SERVICE AND MAINTENANCE

When exchanging a amplifier on a machine, proceed as follows:

- Check that the new amplifier has got the same voltage and current ratings as well as the same hardware configuration as the one to be replaced.
- Reload and save the parameters of the old amplifier via the serial link or the **CANopen** interface.

The new amplifier is now ready for operation.